

SCANIA



SCANIA

Page No

CB.104.000	3 SERIES TRUCK/BUS	233
CB.105.000	3 SERIES TRUCK/BUS	235
CB.106.000	3 SERIES TRUCK/BUS	237
CB.107.000	3 SERIES TRUCK/BUS	239
CK.110.000	4 SERIES TRUCK/BUS	241
CK.111.000	4 SERIES TRUCK/BUS	243
CK.115.000	4 SERIES / P.G.N.T TRUCK	245
CK.120.000	4 SERIES TRUCK	247
CK.125.000	4 SERIES / P.G.N.T TRUCK	249
CK.131.000	4 SERIES TRUCK/BUS	251
CK.152.000	4 SERIES / P.G.N.T TRUCK	253
CK.155.000	4 SERIES / P.G.N.T TRUCK	255
CK.170.000	P.R.T TRUCK, F BUS	257
CK.211.000	4 SERIES BUS / F.K.N BUS	259
CK.212.000	4 SERIES TRUCK	261
CK.246.000	P.G.R.T TRUCK / F.K.N BUS	263
CK.279.000	P.G.R.T TRUCK / F.K.N BUS	265



www.wbs-auto.com

SCANIA

CB.104.000

SCANIA
1300366
394441
571181

KNORR-BREMSE
KZ1228/1
KZ1228

VEHICLE APPLICATION
3 SERIES TRUCK
3 SERIES BUS



Cylinder Bore	Ø75.00	Number of Cylinders	2	Water or Air Cooled	Water	Unloader Port Size	-
Stroke	50 mm	Air Inlet Port Size	M26x1,5	Through Drive	Gear	Water Inlet Port Size	M16x1,5
Swept Volume	440 cm ³	Air Delivery Port Size	M26x1,5	With ESS System	-	Water Delivery Port Size	M16x1,5

<p>Complete Cylinderhead CB.104.100</p>	<p>Cylinder Head CB.104.1020</p> <p>SCANIA : 1104991</p>	<p>Valve Plate CB.104.1040</p> <p>SCANIA : 280694 / 1322813</p>
<p>Repair Kit CB.104.903</p>	<p>Gasket Kit CB.104.905</p>	<p>Repair Kit CB.104.912</p> <p>SCANIA : 1327886 KNORR-BREMSE : I810150061</p>

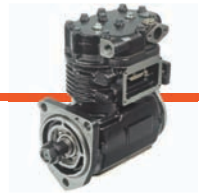

Piston & Ring 75.00 mm CB.103.350

2.38+2.38+3.94

75.25 mm CB.103.960

75.50 mm CB.103.970

VOLVO : 3094151

Piston 75.00 mm CB.103.351

75.25 mm CB.103.961

75.50 mm CB.103.971

VOLVO : 1697706

Ring 75.00 mm CB.103.352

2.38+2.38+3.94

75.25 mm CB.103.962

75.50 mm CB.103.972

VOLVO : 3094155

Crankcase CB.104.400

Connecting Rod CB.103.500

SCANIA : 232063 / 1322814
KNORR-BREMSE : KW3127-1

Crankshaft CB.103.601

SCANIA : 232056
KNORR-BREMSE : KY1564-1

Bushing CB.103.727

39x35x25

Rear Cover CB.103.720

Aluminum Bushing Cover

SCANIA : 251759 / 1322816
KNORR-BREMSE : KY1223-11

Ball Bearing 6207

SCANIA : 14091

Valve Seat Kit CB.104.914

Full Repair Kit CB.104.901

CB.105.000

SCANIA
1327231
232615
KNORR-BREMSE
KZ396/2
KZ396/3
1118844

VEHICLE APPLICATION
3 SERIES TRUCK
3 SERIES BUS



Cylinder Bore	Ø75.00	Number of Cylinders	2	Water or Air Cooled	Water	Unloader Port Size	-
Stroke	50 mm	Air Inlet Port Size	M26x1,5	Through Drive	Gear	Water Inlet Port Size	M16x1,5
Swept Volume	440 cm ³	Air Delivery Port Size	M26x1,5	With ESS System	-	Water Delivery Port Size	M16x1,5

<p>Complete Cylinderhead CB.105.100</p>	<p>Cylinder Head CB.105.1020</p> <p>SCANIA : 232032</p>	<p>Valve Plate CB.104.1040</p> <p>SCANIA : 280694 / 1322813</p>
<p>Repair Kit CB.104.903</p>	<p>Gasket Kit CB.104.905</p>	<p>Repair Kit CB.104.912</p> <p>SCANIA : 1327886 KNORR-BREMSE : I810150061</p>

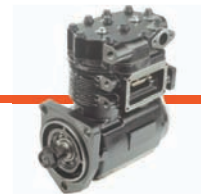

Piston & Ring 75.00 mm CB.103.350

2.38+2.38+3.94

75.25 mm CB.103.960

75.50 mm CB.103.970

VOLVO : 3094151

Piston 75.00 mm CB.103.351

75.25 mm CB.103.961

75.50 mm CB.103.971

VOLVO : 1697706

Ring 75.00 mm CB.103.352

2.38+2.38+3.94

75.25 mm CB.103.962

75.50 mm CB.103.972

VOLVO : 3094155

Crankcase CB.105.400

SCANIA : 232041

Connecting Rod CB.103.500

SCANIA : 232063 / 1322814
KNORR-BREMSE : KW3127-1

Crankshaft CB.103.601

SCANIA : 232056
KNORR-BREMSE : KY1564-1

Bushing CB.103.727

39x35x25

Rear Cover CB.103.720

Aluminum Bushing Cover

SCANIA : 251759 / 1322816
KNORR-BREMSE : KY1223-11

Ball Bearing 6207

SCANIA : 14091

Valve Seat Kit CB.104.914

Full Repair Kit CB.104.901

CB.106.000

SCANIA
1348919
300162
571185

KNORR-BREMSE
KZ642/2
1189106

VEHICLE APPLICATION
3 SERIES TRUCK
3 SERIES BUS



Cylinder Bore	Ø75.00	Number of Cylinders	2	Water or Air Cooled	Water	Unloader Port Size	-
Stroke	50 mm	Air Inlet Port Size	M26x1,5	Through Drive	Gear	Water Inlet Port Size	M16x1,5
Swept Volume	440 cm ³	Air Delivery Port Size	M26x1,5	With ESS System	-	Water Delivery Port Size	M16x1,5

<p>Complete Cylinderhead CB.106.100</p>	<p>Cylinder Head CB.106.1020</p> <p>SCANIA : 280676</p>	<p>Valve Plate CB.104.1040</p> <p>SCANIA : 280694 / 1322813</p>
<p>Repair Kit CB.104.903</p>	<p>Gasket Kit CB.104.905</p>	<p>Repair Kit CB.104.912</p> <p>SCANIA : 1327886 KNORR-BREMSE : I810150061</p>



Piston & Ring 75.00 mm CB.103.350

2.38+2.38+3.94

75.25 mm CB.103.960

75.50 mm CB.103.970

VOLVO : 3094151

Piston 75.00 mm CB.103.351

75.25 mm CB.103.961

75.50 mm CB.103.971

VOLVO : 1697706

Ring 75.00 mm CB.103.352

2.38+2.38+3.94

75.25 mm CB.103.962

75.50 mm CB.103.972

VOLVO : 3094155

Crankcase CB.106.400

Connecting Rod CB.103.500

SCANIA : 232063 / 1322814
KNORR-BREMSE : KW3127-1

Crankshaft CB.103.601

SCANIA : 232056
KNORR-BREMSE : KY1564-1

Bushing CB.103.727

39x35x25

Rear Cover CB.103.720

Aluminum Bushing Cover

SCANIA : 251759 / 1322816
KNORR-BREMSE : KY1223-11

Ball Bearing 6207

SCANIA : 14091

Valve Seat Kit CB.104.914

Full Repair Kit CB.104.901

CB.107.000

SCANIA
1348920
301525
1314107

KNORR-BREMSE
KZ996/2
1189107

VEHICLE APPLICATION
3 SERIES TRUCK
3 SERIES BUS



Cylinder Bore	Ø75.00	Number of Cylinders	2	Water or Air Cooled	Water	Unloader Port Size	-
Stroke	50 mm	Air Inlet Port Size	M26x1,5	Through Drive	Gear	Water Inlet Port Size	M16x1,5
Swept Volume	440 cm ³	Air Delivery Port Size	M26x1,5	With ESS System	-	Water Delivery Port Size	M16x1,5

<p>Complete Cylinderhead CB.107.100</p>	<p>Cylinder Head CB.107.1020</p> <p>SCANIA : 366810</p>	<p>Valve Plate CB.104.1040</p> <p>SCANIA : 280694 / 1322813</p>
<p>Repair Kit CB.104.903</p>	<p>Gasket Kit CB.104.905</p>	<p>Repair Kit CB.104.912</p> <p>SCANIA : 1327886 KNORR-BREMSE : I810150061</p>



Piston & Ring 75.00 mm CB.103.350

2.38+2.38+3.94

75.25 mm CB.103.960

75.50 mm CB.103.970

VOLVO : 3094151

Piston 75.00 mm CB.103.351

75.25 mm CB.103.961

75.50 mm CB.103.971

VOLVO : 1697706

Ring 75.00 mm CB.103.352

2.38+2.38+3.94

75.25 mm CB.103.962

75.50 mm CB.103.972

VOLVO : 3094155

Crankcase CB.107.400

SCANIA : 1104990 / 366809

Connecting Rod CB.103.500

SCANIA : 232063 / 1322814
KNORR-BREMSE : KW3127-1

Crankshaft CB.103.601

SCANIA : 232056
KNORR-BREMSE : KY1564-1

Bushing CB.103.727

39x35x25

Rear Cover CB.103.720

Aluminum Bushing Cover

SCANIA : 251759 / 1322816
KNORR-BREMSE : KY1223-11

Ball Bearing 6207

SCANIA : 14091

Valve Seat Kit CB.104.914

Full Repair Kit CB.104.901

CK.110.000

SCANIA
571183
1303226

KNORR-BREMSE
LP4814
I97492

VEHICLE APPLICATION
3 SERIES TRUCK
3 SERIES BUS
4 SERIES TRUCK
4 SERIES BUS
4 SERIES HEAVY DUTY



Cylinder Bore	Ø75.00	Number of Cylinders	2	Water or Air Cooled	Water	Unloader Port Size	-
Stroke	50 mm	Air Inlet Port Size	M26x1,5	Through Drive	Gear	Water Inlet Port Size	M16x1,5
Swept Volume	440 cm ³	Air Delivery Port Size	M26x1,5	With ESS System	-	Water Delivery Port Size	M16x1,5

<p>Complete Cylinderhead CK.110.1000</p> 	<p>Cylinderhead CK.110.1010</p>  <p>SCANIA : 1315299 KNORR-BREMSE : SEB22587</p>	<p>Complete Valve Plate CK.110.200</p>  <p>SCANIA : 1315377 / 1315372 KNORR-BREMSE : I81015004</p>
<p>Valve Plate CK.110.2010</p> 	<p>Repair Kit CK.110.903</p>  <p>SCANIA : 1315376 KNORR-BREMSE : SEB22541</p>	<p>Repair Kit CK.110.904</p> 



Piston & Ring 75.00 mm CK.108.350

2.00+2.00+4.00

75.25 mm CK.108.960

75.50 mm CK.108.970

SCANIA : 1315279 / 1315280
KNORR-BREMSE : SEB22539 / SEB22540

Piston 75.00 mm CK.108.351

75.25 mm CK.108.961

75.50 mm CK.108.971

Ring 75.00 mm CW.108.352

2.00+2.00+4.00

75.25 mm CW.108.962

75.50 mm CW.108.972

SCANIA : 1391384 / 1391385
KNORR-BREMSE : I801770061

Crankcase CK.108.400

SCANIA : 1315275

Connecting Rod CK.108.500

SCANIA : 1315278
KNORR-BREMSE : SEB00626004 / SEB00957004

Crankshaft CK.108.601

SCANIA : 1315290
KNORR-BREMSE : EB007622V / EB00762

Bushing CK.116.434

42x38x25

SCANIA : 1315274
KNORR-BREMSE : EB00819

Rear Cover CK.108.720

Aluminum Bushing Cover

SCANIA : 1315292
KNORR-BREMSE : SEB00387004

Gasket Kit CK.110.905

KNORR-BREMSE : SEB22542

Valve Kit CK.110.906

KNORR-BREMSE : II326840061

Repair Kit CK.110.911

KNORR-BREMSE : SEB22560

Nut MC202061FX

SCANIA : 1315273

CK.111.000

SCANIA
571184
1303227

KNORR-BREMSE
LP4815
I97493

VEHICLE APPLICATION
3 SERIES TRUCK
3 SERIES BUS
4 SERIES TRUCK
4 SERIES BUS
4 SERIES HEAVY DUTY



Cylinder Bore	Ø75.00	Number of Cylinders	2	Water or Air Cooled	Water	Unloader Port Size	-
Stroke	50 mm	Air Inlet Port Size	M26x1,5	Through Drive	Gear	Water Inlet Port Size	M16x1,5
Swept Volume	440 cm ³	Air Delivery Port Size	M26x1,5	With ESS System	-	Water Delivery Port Size	M16x1,5

<p>Complete Cylinderhead CK.110.1000</p> 	<p>Cylinderhead CK.110.1010</p>  <p>SCANIA : 1315299 KNORR-BREMSE : SEB22587</p>	<p>Complete Valve Plate CK.110.200</p>  <p>SCANIA : 1315377 / 1315372 KNORR-BREMSE : I81015004</p>
<p>Valve Plate CK.110.2010</p> 	<p>Repair Kit CK.110.903</p>  <p>SCANIA : 1315376 KNORR-BREMSE : SEB22541</p>	<p>Repair Kit CK.110.904</p> 



Piston & Ring 75.00 mm CK.108.350

2.00+2.00+4.00

75.25 mm CK.108.960

75.50 mm CK.108.970

SCANIA : 1315279 / 1315280
KNORR-BREMSE : SEB22539 / SEB22540

Piston 75.00 mm CK.108.351

75.25 mm CK.108.961

75.50 mm CK.108.971

Ring 75.00 mm CW.108.352

2.00+2.00+4.00

75.25 mm CW.108.962

75.50 mm CW.108.972

SCANIA : 1391384 / 1391385
KNORR-BREMSE : I801770061

Crankcase CK.108.400

SCANIA : 1315275

Connecting Rod CK.108.500

SCANIA : 1315278
KNORR-BREMSE : SEB00626004 / SEB00957004

Crankshaft CK.108.601

SCANIA : 1315290
KNORR-BREMSE : EB007622V / EB00762

Bushing CK.116.434

42x38x25

SCANIA : 1315274
KNORR-BREMSE : EB00819

Rear Cover CK.108.720

Aluminum Bushing Cover

SCANIA : 1315292
KNORR-BREMSE : SEB00387004

Gasket Kit CK.110.905

KNORR-BREMSE : SEB22542

Valve Kit CK.110.906

KNORR-BREMSE : I1326840061

Repair Kit CK.110.911

KNORR-BREMSE : SEB22560

Nut MC202061FX

SCANIA : 1315273

CK.115.000

SCANIA
1514063
1470303
1380455
571286

KNORR-BREMSE
LP4964
II32687

VEHICLE APPLICATION

4 SERIES TRUCK
4 SERIES BUS
P,G,N,T TRUCK
F,K,N BUS
D9, D11, D12, D12A, D13
DC9, DC9A, DC11
DC12, DC13, DSC1205
DSC12, SG9, K94



Cylinder Bore	Ø88.00	Number of Cylinders	2	Water or Air Cooled	Water	Unloader Port Size	M22x1,5
Stroke	50 mm	Air Inlet Port Size	Ø29	Through Drive	Gear	Water Inlet Port Size	M16x1,5
Swept Volume	608 cm ³	Air Delivery Port Size	M26x1,5	With ESS System	Yes	Water Delivery Port Size	M16x1,5

<p>Complete Cylinderhead CK.115.1000</p>	<p>Cylinderhead CK.115.1010</p> <p>LK4951 / LP4964 / LP4965 / LP4966</p> <p>Top View</p> <p>Bottom View</p> <p>SCANIA : 1424766 KNORR-BREMSE : SEB01444004</p>	<p>Complete Valve Plate CK.115.200</p> <p>SCANIA : 1376272 KNORR-BREMSE : SEB01033004</p>
<p>Valve Plate CK.115.2010</p>	<p>Repair Kit CK.115.903</p>	<p>Repair Kit CK.115.905</p> <p>SCANIA : 1376281 / 1542159 KNORR-BREMSE : SEB22561</p>



Piston & Ring 88.00 mm CK.116.350

2.50+2.50+4.00

88.25 mm CK.116.960

88.50 mm CK.116.970

VOLVO : 85101375 / 3095841 / 1698848
KNORR-BREMSE : SEB22555

Piston 88.00 mm CK.116.351

88.25 mm CK.116.961

88.50 mm CK.116.971

Ring 88.00 mm CK.116.352

2.50+2.50+4.00

88.25 mm CK.116.962

88.50 mm CK.116.972

VOLVO : 85100626 / 3097153
KNORR-BREMSE : II39526F0061

Crankcase CK.115.400

Connecting Rod CK.116.500

KNORR-BREMSE : SEB00967004

Crankshaft CK.115.601

Bushing CK.116.434

42x38x25

SCANIA : 1315274
KNORR-BREMSE : EB00819

Rear Cover CK.116.720

Aluminum Bushing Cover

SCANIA : 1376275
KNORR-BREMSE : SEB013090065 / II159920065

Valve Kit CK.115.907

SCANIA : 1376280
KNORR-BREMSE : II326840061

Valve Kit CK.115.908

SCANIA : 1391386
KNORR-BREMSE : SEB01138004 / SEB011380061

Repair Kit CK.115.912

KNORR-BREMSE : SEB22560

Repair Kit CK.115.921

SCANIA : 1376279
KNORR-BREMSE : II159920063

CK.120.000

SCANIA
1349094
1513115
571188
1531073

KNORR-BREMSE
LP4957
II17395

VEHICLE APPLICATION
4 SERIES TRUCK



Cylinder Bore	Ø88.00	Number of Cylinders	2	Water or Air Cooled	Water	Unloader Port Size	M22x1,5
Stroke	50 mm	Air Inlet Port Size	Ø29	Through Drive	Gear	Water Inlet Port Size	M16x1,5
Swept Volume	608 cm ³	Air Delivery Port Size	M26x1,5	With ESS System	Yes	Water Delivery Port Size	M16x1,5

<p>Complete Cylinderhead CK.120.1000</p>	<p>Cylinderhead CK.120.1010</p> <p>LP4957 / LP4962 / LP4963</p> <p>Top View</p> <p>Bottom View</p> <p>SCANIA : 1376274 KNORR-BREMSE : SEB01106004</p>	<p>Complete Valve Plate CK.115.200</p> <p>SCANIA : 1376272 KNORR-BREMSE : SEB01033004</p>
<p>Valve Plate CK.115.2010</p>	<p>Repair Kit CK.115.903</p>	<p>Repair Kit CK.115.905</p> <p>SCANIA : 1376281 / 1542159 KNORR-BREMSE : SEB22561</p>



Piston & Ring 88.00 mm CK.116.350

2.50+2.50+4.00

88.25 mm CK.116.960

88.50 mm CK.116.970



VOLVO : 85101375 / 3095841 / 1698848
KNORR-BREMSE : SEB22555

Piston 88.00 mm CK.116.351

88.25 mm CK.116.961

88.50 mm CK.116.971



Ring 88.00 mm CK.116.352

2.50+2.50+4.00

88.25 mm CK.116.962

88.50 mm CK.116.972



VOLVO : 85100626 / 3097153
KNORR-BREMSE : II39526F0061

Crankcase CK.120.400



Connecting Rod CK.116.500



KNORR-BREMSE : SEB00967004

Crankshaft CK.115.601



Bushing CK.116.434

42x38x25



SCANIA : 1315274
KNORR-BREMSE : EB00819

Rear Cover CK.116.720

Aluminum Bushing Cover



SCANIA : 1376275
KNORR-BREMSE : SEB013090065 / II159920065

Valve Kit CK.115.907



SCANIA : 1376280
KNORR-BREMSE : II326840061

Valve Kit CK.115.908



SCANIA : 1391386
KNORR-BREMSE : SEB01138004 / SEB011380061

Repair Kit CK.115.912



KNORR-BREMSE : SEB22560

Repair Kit CK.115.921



SCANIA : 1376279
KNORR-BREMSE : II159920063

CK.125.000

SCANIA
1380457
571287
1514064
1470304
571039
1728435

KNORR-BREMSE
LP4965
II32688

VEHICLE APPLICATION

4 SERIES TRUCK
4 SERIES BUS
P,G,N,T TRUCK
F,K,N BUS
D9, D11, D12, D12A, D13
DC9, DC9A, DC11
DC12, DC13, DSC1205
DSC12, SG9, K94



Cylinder Bore	Ø88.00	Number of Cylinders	2	Water or Air Cooled	Water	Unloader Port Size	M22x1,5
Stroke	50 mm	Air Inlet Port Size	Ø29	Through Drive	Gear	Water Inlet Port Size	M16x1,5
Swept Volume	608 cm ³	Air Delivery Port Size	M26x1,5	With ESS System	Yes	Water Delivery Port Size	M16x1,5

<p>Complete Cylinderhead CK.115.1000</p>	<p>Cylinderhead CK.115.1010</p> <p>LK4951 / LP4964 / LP4965 / LP4966</p> <p>Top View</p> <p>Bottom View</p> <p>SCANIA : 1424766 KNORR-BREMSE : SEB01444004</p>	<p>Complete Valve Plate CK.115.200</p> <p>SCANIA : 1376272 KNORR-BREMSE : SEB01033004</p>
<p>Valve Plate CK.115.2010</p>	<p>Repair Kit CK.115.903</p>	<p>Repair Kit CK.115.905</p> <p>SCANIA : 1376281 / 1542159 KNORR-BREMSE : SEB22561</p>



Piston & Ring 88.00 mm CK.116.350

2.50+2.50+4.00

88.25 mm CK.116.960

88.50 mm CK.116.970

VOLVO : 85101375 / 3095841 / 1698848
KNORR-BREMSE : SEB22555

Piston 88.00 mm CK.116.351

88.25 mm CK.116.961

88.50 mm CK.116.971

Ring 88.00 mm CK.116.352

2.50+2.50+4.00

88.25 mm CK.116.962

88.50 mm CK.116.972

VOLVO : 85100626 / 3097153
KNORR-BREMSE : I139526F0061

Crankcase CK.125.400

Connecting Rod CK.116.500

KNORR-BREMSE : SEB00967004

Crankshaft CK.125.601

Bushing CK.116.434

42x38x25

SCANIA : 1315274
KNORR-BREMSE : EB00819

Rear Cover CK.125.720

Aluminum Bushing Cover

SCANIA : 1932013
KNORR-BREMSE : K036087K50

Valve Kit CK.115.907

SCANIA : 1376280
KNORR-BREMSE : I1326840061

Valve Kit CK.115.908

SCANIA : 1391386
KNORR-BREMSE : SEB01138004 / SEB011380061

Repair Kit CK.115.912

KNORR-BREMSE : SEB22560

Repair Kit CK.115.921

SCANIA : 1376279
KNORR-BREMSE : I1159920063

CK.131.000

SCANIA
1381951
1381961

KNORR-BREMSE
LP4844

VEHICLE APPLICATION
3 SERIES TRUCK
3 SERIES BUS
4 SERIES TRUCK
4 SERIES BUS
4 SERIES HEAVY DUTY



Cylinder Bore	Ø75.00	Number of Cylinders	2	Water or Air Cooled	Water	Unloader Port Size	-
Stroke	50 mm	Air Inlet Port Size	M26x1,5	Through Drive	Gear	Water Inlet Port Size	M16x1,5
Swept Volume	440 cm ³	Air Delivery Port Size	M26x1,5	With ESS System	-	Water Delivery Port Size	M16x1,5

<p>Complete Cylinderhead CK.110.1000</p> 	<p>Cylinderhead CK.110.1010</p>  <p>SCANIA : 1315299 KNORR-BREMSE : SEB22587</p>	<p>Complete Valve Plate CK.110.200</p>  <p>SCANIA : 1315377 / 1315372 KNORR-BREMSE : I81015004</p>
<p>Valve Plate CK.110.2010</p> 	<p>Repair Kit CK.110.903</p>  <p>SCANIA : 1315376 KNORR-BREMSE : SEB22541</p>	<p>Repair Kit CK.110.904</p> 



Piston & Ring 75.00 mm CK.108.350

2.00+2.00+4.00

75.25 mm CK.108.960

75.50 mm CK.108.970

SCANIA : 1315279 / 1315280
KNORR-BREMSE : SEB22539 / SEB22540

Piston 75.00 mm CK.108.351

75.25 mm CK.108.961

75.50 mm CK.108.971

Ring 75.00 mm CW.108.352

2.00+2.00+4.00

75.25 mm CW.108.962

75.50 mm CW.108.972

SCANIA : 1391384 / 1391385
KNORR-BREMSE : I801770061

Crankcase CK.131.400

Connecting Rod CK.108.500

SCANIA : 1315278
KNORR-BREMSE : SEB00626004 / SEB00957004

Crankshaft CK.108.601

SCANIA : 1315290
KNORR-BREMSE : EB007622V / EB00762

Bushing CK.116.434

42x38x25

SCANIA : 1315274
KNORR-BREMSE : EB00819

Rear Cover CK.108.720

Aluminum Bushing Cover

SCANIA : 1315292
KNORR-BREMSE : SEB00387004

Gasket Kit CK.110.905

KNORR-BREMSE : SEB22542

Valve Kit CK.110.906

KNORR-BREMSE : I1326840061

Repair Kit CK.110.911

KNORR-BREMSE : SEB22560

Nut MC202061FX

SCANIA : 1315273

CK.152.000

SCANIA
1541705
1770607
1796663
KNORR-BREMSE
LK4941

VEHICLE APPLICATION
4 SERIES TRUCK
4 SERIES BUS
P,G,N,T TRUCK
F,K,N BUS
D9, D11, D12, D12A, D13
DC9, DC9A, DC11
DC12, DC13, DSC1205
DSC12, SG9, K94



Cylinder Bore	Ø88.00	Number of Cylinders	2	Water or Air Cooled	Water	Unloader Port Size	M22x1,5
Stroke	50 mm	Air Inlet Port Size	Ø29	Through Drive	Gear	Water Inlet Port Size	M16x1,5
Swept Volume	608 cm ³	Air Delivery Port Size	M26x1,5	With ESS System	Yes	Water Delivery Port Size	M16x1,5

<p>Complete Cylinderhead CK.115.1000</p>	<p>Cylinderhead CK.115.1010</p> <p>LK4951 / LP4964 / LP4965 / LP4966</p> <p>Top View</p> <p>Bottom View</p> <p>SCANIA : 1424766 KNORR-BREMSE : SEB01444004</p>	<p>Complete Valve Plate CK.115.200</p> <p>SCANIA : 1376272 KNORR-BREMSE : SEB01033004</p>
<p>Valve Plate CK.115.2010</p>	<p>Repair Kit CK.115.903</p>	<p>Repair Kit CK.115.905</p> <p>SCANIA : 1376281 / 1542159 KNORR-BREMSE : SEB22561</p>



Piston & Ring 88.00 mm CK.116.350

2.50+2.50+4.00

88.25 mm CK.116.960

88.50 mm CK.116.970

VOLVO : 85101375 / 3095841 / 1698848
KNORR-BREMSE : SEB22555

Piston 88.00 mm CK.116.351

88.25 mm CK.116.961

88.50 mm CK.116.971

Ring 88.00 mm CK.116.352

2.50+2.50+4.00

88.25 mm CK.116.962

88.50 mm CK.116.972

VOLVO : 85100626 / 3097153
KNORR-BREMSE : I139526F0061

Crankcase CK.125.400

Connecting Rod CK.116.500

KNORR-BREMSE : SEB00967004

Crankshaft CK.125.601

Bushing CK.116.434

42x38x25

SCANIA : 1315274
KNORR-BREMSE : EB00819

Rear Cover CK.152.720

Aluminum Bushing Cover

SCANIA : 1932013
KNORR-BREMSE : K036087K50

Valve Kit CK.115.907

SCANIA : 1376280
KNORR-BREMSE : I1326840061

Valve Kit CK.115.908

SCANIA : 1391386
KNORR-BREMSE : SEB01138004 / SEB011380061

Repair Kit CK.115.912

KNORR-BREMSE : SEB22560

Repair Kit CK.115.921

SCANIA : 1376279
KNORR-BREMSE : I1159920063

CK.155.000

SCANIA
1380456
1132686

KNORR-BREMSE
LP4962

VEHICLE APPLICATION
4 SERIES TRUCK
4 SERIES BUS
P,G,N,T TRUCK
F,K,N BUS



Cylinder Bore	Ø88.00	Number of Cylinders	2	Water or Air Cooled	Water	Unloader Port Size	M22x1,5
Stroke	50 mm	Air Inlet Port Size	Ø29	Through Drive	Gear	Water Inlet Port Size	M16x1,5
Swept Volume	608 cm ³	Air Delivery Port Size	M26x1,5	With ESS System	Yes	Water Delivery Port Size	M16x1,5

<p>Complete Cylinderhead CK.120.1000</p>	<p>Cylinderhead CK.120.1010</p> <p>LP4957 / LP4962 / LP4963</p> <p>Top View</p> <p>Bottom View</p> <p>SCANIA : 1376274 KNORR-BREMSE : SEB01106004</p>	<p>Complete Valve Plate CK.115.200</p> <p>SCANIA : 1376272 KNORR-BREMSE : SEB01033004</p>
<p>Valve Plate CK.115.2010</p>	<p>Repair Kit CK.115.903</p>	<p>Repair Kit CK.115.905</p> <p>SCANIA : 1376281 / 1542159 KNORR-BREMSE : SEB22561</p>



Piston & Ring 88.00 mm CK.116.350

2.50+2.50+4.00

88.25 mm CK.116.960

88.50 mm CK.116.970

VOLVO : 85101375 / 3095841 / 1698848
KNORR-BREMSE : SEB22555

Piston 88.00 mm CK.116.351

88.25 mm CK.116.961

88.50 mm CK.116.971

Ring 88.00 mm CK.116.352

2.50+2.50+4.00

88.25 mm CK.116.962

88.50 mm CK.116.972

VOLVO : 85100626 / 3097153
KNORR-BREMSE : II39526F0061

Crankcase CK.115.400

Connecting Rod CK.116.500

KNORR-BREMSE : SEB00967004

Crankshaft CK.115.601

Bushing CK.116.434

42x38x25

SCANIA : 1315274
KNORR-BREMSE : EB00819

Rear Cover CK.116.720

Aluminum Bushing Cover

SCANIA : 1376275
KNORR-BREMSE : SEB013090065 / II159920065

Valve Kit CK.115.907

SCANIA : 1376280
KNORR-BREMSE : II326840061

Valve Kit CK.115.908

SCANIA : 1391386
KNORR-BREMSE : SEB01138004 / SEB011380061

Repair Kit CK.115.912

KNORR-BREMSE : SEB22560

Repair Kit CK.115.921

SCANIA : 1376279
KNORR-BREMSE : II159920063

CK.170.000







SCANIA
1514065

KNORR-BREMSE
LK3976
K002580

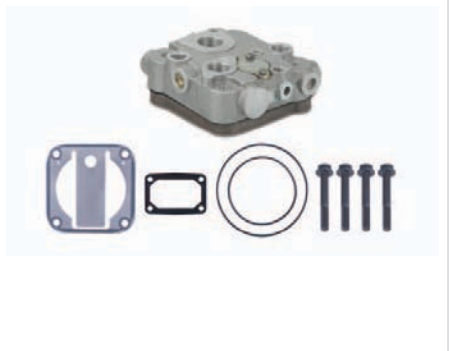
VEHICLE APPLICATION
4 SERIES TRUCK
4 SERIES BUS
F94 / P114 / P124 / P94
R114 / R124 / T114 / T124

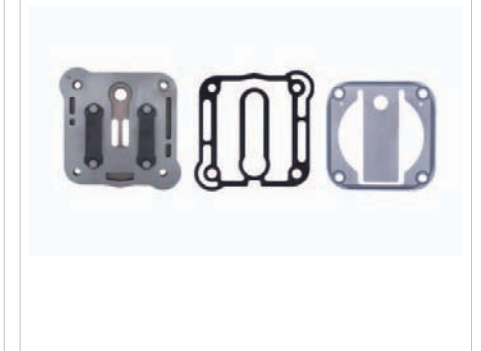

Cylinder Bore	Ø92.00	Number of Cylinders	1	Water or Air Cooled	Water	Unloader Port Size	M10x1
Stroke	54 mm	Air Inlet Port Size	M26x1,5	Through Drive	Gear	Water Inlet Port Size	M16x1,5
Swept Volume	360 cm ³	Air Delivery Port Size	M18x1,5	With ESS System	Yes	Water Delivery Port Size	M16x1,5

<p>Complete Cylinderhead CK.170.100</p> 	<p>Cylinderhead CK.170.1010</p>  <p>SCANIA : 1529446 KNORR-BREMSE : SEB01891</p>	<p>Complete Valve Plate CK.170.200</p> 
<p>Valve Plate CK.170.2010</p>  <p>KNORR-BREMSE : SEB01898 / SEB30070</p>	<p>Repair Kit CK.170.903</p> 	<p>Repair Kit CK.170.912</p>  <p>KNORR-BREMSE : SEB015790069</p>

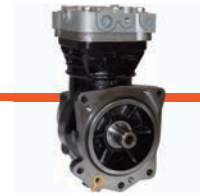

Piston & Ring 92.00 mm CK.173.350

2.50+2.50+4.00

92.25 mm CK.173.960

92.50 mm CK.173.970

KNORR-BREMSE : SEB22530 / K012079 / I139529F

Piston 92.00 mm CK.173.351

92.25 mm CK.173.961

92.50 mm CK.173.971

Ring 92.00 mm CK.165.352

2.50+2.50+4.00

92.25 mm CK.165.962

92.50 mm CK.165.972

KNORR-BREMSE : I139529F0062 STD

Crankcase CK.170.400

KNORR-BREMSE : SEB01667

Connecting Rod CK.191.501

KNORR-BREMSE : SEB01661 / SEB22464

Crankshaft CK.170.601

KNORR-BREMSE : Z009859 / EB02888

Bushing CK.116.434

42x38x25

SCANIA : 1315274

KNORR-BREMSE : EB00819

Rear Cover CK.170.720

Aluminum Bushing Cover

KNORR-BREMSE : SEB01672

Sump Cover CK.165.751

KNORR-BREMSE : EB02766

Gasket Kit CK.170.905

Valve Kit CK.170.906

Unloader Kit CK.170.921

KNORR-BREMSE : SEB22460 / I138147F0061

CK.211.000

SCANIA
1745702
2032484
1537794

KNORR-BREMSE
LK4930

VEHICLE APPLICATION

4 SERIES BUS
F, K, N BUS



Cylinder Bore	Ø92.00	Number of Cylinders	2	Water or Air Cooled	Water	Unloader Port Size	M10x1
Stroke	54 mm	Air Inlet Port Size	M26x1,5	Through Drive	Gear	Water Inlet Port Size	M18x1,5
Swept Volume	720 cm ³	Air Delivery Port Size	M22x1,5	With ESS System	Yes	Water Delivery Port Size	M18x1,5

<p>Complete Cylinderhead CK.211.1000</p>	<p>Cylinder Up Head CK.211.1020</p> <p>KNORR-BREMSE : K012189</p>	<p>Cylinder Bottom Head CK.211.1040</p>
<p>Complete Valve Plate CK.211.200</p> <p>KNORR-BREMSE : K012074</p>	<p>Valve Plate CK.211.2010</p>	<p>Repair Kit CK.211.903</p>



Piston & Ring 92.00 mm CK.173.350

2.50+2.50+4.00

92.25 mm CK.173.960

92.50 mm CK.173.970

KNORR-BREMSE : SEB22530 / K012079

Piston 92.00 mm CK.173.351

92.25 mm CK.173.961

92.50 mm CK.173.971

Ring 92.00 mm CK.165.352

2.50+2.50+4.00

92.25 mm CK.165.962

92.50 mm CK.165.972

Crankcase CK.211.400

Connecting Rod CK.173.500

Crankshaft CK.211.601

Bushing CK.116.434

42x38x25

SCANIA : 1315274
KNORR-BREMSE : EB00819

Rear Cover CK.211.720

Aluminum Bushing Cover

Repair Kit CK.211.901

Repair Kit CK.211.911

Repair Kit CK.211.913

KNORR-BREMSE : K012086

Valve Kit CK.211.921

KNORR-BREMSE : K034874K50

CK.212.000

SCANIA
1390008

KNORR-BREMSE
LK3972
I134848

VEHICLE APPLICATION
4 SERIES TRUCK



Cylinder Bore	Ø88.00	Number of Cylinders	1	Water or Air Cooled	Water	Unloader Port Size	-
Stroke	50 mm	Air Inlet Port Size	M26x1,5	Through Drive	Pulley	Water Inlet Port Size	M22x1,5
Swept Volume	300 cm ³	Air Delivery Port Size	M26x1,5	With ESS System	-	Water Delivery Port Size	M22x1,5

<p>Complete Cylinderhead CK.212.100</p> <p>KNORR-BREMSE : K021494K50</p>	<p>Cylinderhead CK.212.1010</p> <p>SCANIA : 1409326 KNORR-BREMSE : I94672</p>	<p>Complete Valve Plate CK.212.200</p> <p>KNORR-BREMSE : I94056004</p>
<p>Valve Plate CK.212.2010</p> <p>KNORR-BREMSE : I90153004 / I93078004</p>	<p>Repair Kit CK.212.903</p>	<p>Repair Kit CK.212.904</p> <p>KNORR-BREMSE : I880570061 / I38715F004</p>



Piston & Ring

88.00 mm CK.116.350

88.25 mm CK.116.960

88.50 mm CK.116.970

KNORR-BREMSE : SEB22555

Piston

88.00 mm CK.116.351

88.25 mm CK.116.961

88.50 mm CK.116.971

Ring

88.00 mm CW.116.352

2.00+2.00+4.00

88.25 mm CW.116.962

88.50 mm CW.116.972

Crankcase

CK.138.400

KNORR-BREMSE : 160599

Connecting Rod

CK.105.501

KNORR-BREMSE : 160599

Crankshaft

CK.105.601

Cylinder Liner & Piston

CK.105.300

STD. Piston & Ring

Cylinder Liner

CK.105.3010

Flange Cover

CK.104.700

KNORR-BREMSE : 186897

Bushing

CK.102.708

34x30x16

KNORR-BREMSE : B64572

Bushing

CK.102.434

34x30x16

KNORR-BREMSE : B44935

Repair Kit

CK.212.905

CK.246.000

SCANIA
1880194
KNORR-BREMSE
LK4951 - K024410N05
LK4951 - K024410N00

VEHICLE APPLICATION
P,G,N,T TRUCK
F, K, N BUS



Cylinder Bore	Ø86.00	Number of Cylinders	2	Water or Air Cooled	Water	Unloader Port Size	M10x1
Stroke	62 mm	Air Inlet Port Size	M26x1,5	Through Drive	Gear	Water Inlet Port Size	M18x1,5
Swept Volume	720 cm ³	Air Delivery Port Size	M22x1,5	With ESS System	Yes	Water Delivery Port Size	M18x1,5

<p>Complete Cylinderhead CK.246.1000</p>	<p>Cylinder Up Head CK.246.1020</p> <p>KNORR-BREMSE : K018810</p>	<p>Cylinder Bottom Head CK.246.1040</p>
<p>Complete Valve Plate CK.246.200</p> <p>KNORR-BREMSE : K018806</p>	<p>Valve Plate CK.246.2010</p>	<p>Repair Kit CK.246.903</p>

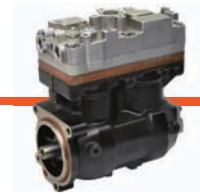

Piston & Ring 86.00 mm CK.157.350

2.00+2.00+3.00

86.25 mm CK.157.960

86.50 mm CK.157.970

KNORR-BREMSE : SEB22547 / SEB22548

Piston 86.00 mm CK.157.351

86.25 mm CK.157.961

86.50 mm CK.157.971

Ring 86.00 mm CK.157.352

2.00+2.00+3.00

86.25 mm CK.157.962

86.50 mm CK.157.972

Crankcase CK.246.400

Connecting Rod CK.173.500

Crankshaft CK.246.601

Bushing CK.116.434

42x38x25

SCANIA : 1315274
KNORR-BREMSE : EB00819

Rear Cover CK.246.720

Aluminum Bushing Cover

Repair Kit CK.246.901

Repair Kit CK.246.910

Valve Kit CK.246.906

Valve Kit CK.211.921

KNORR-BREMSE : K034874K50

CK.279.000

SCANIA
2024413
KNORR-BREMSE
LK4951 - K053740N05
LK4951 - K053740N00

VEHICLE APPLICATION
P,G,N,T TRUCK
F, K, N BUS

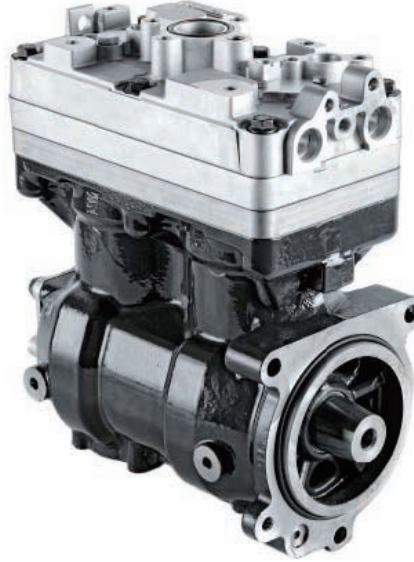

Cylinder Bore	Ø86.00	Number of Cylinders	2	Water or Air Cooled	Water	Unloader Port Size	M10x1
Stroke	62 mm	Air Inlet Port Size	M26x1,5	Through Drive	Gear	Water Inlet Port Size	M18x1,5
Swept Volume	720 cm ³	Air Delivery Port Size	M22x1,5	With ESS System	Yes	Water Delivery Port Size	M18x1,5

<p>Complete Cylinderhead CK.246.1000</p>	<p>Cylinder Up Head CK.246.1020</p> <p>KNORR-BREMSE : K018810</p>	<p>Cylinder Bottom Head CK.246.1040</p>
<p>Complete Valve Plate CK.246.200</p> <p>KNORR-BREMSE : K018806</p>	<p>Valve Plate CK.246.2010</p>	<p>Repair Kit CK.246.903</p>



Piston & Ring 86.00 mm CK.157.350

2.00+2.00+3.00

86.25 mm CK.157.960

86.50 mm CK.157.970



KNORR-BREMSE : SEB22547 / SEB22548

Piston 86.00 mm CK.157.351

86.25 mm CK.157.961

86.50 mm CK.157.971



Ring 86.00 mm CK.157.352

2.00+2.00+3.00

86.25 mm CK.157.962

86.50 mm CK.157.972



Crankcase CK.246.400



Connecting Rod CK.173.500



Crankshaft CK.279.601



Bushing CK.116.434

42x38x25



SCANIA : 1315274
KNORR-BREMSE : EB00819

Rear Cover CK.246.720

Aluminum Bushing Cover



Repair Kit CK.246.901



Repair Kit CK.246.910

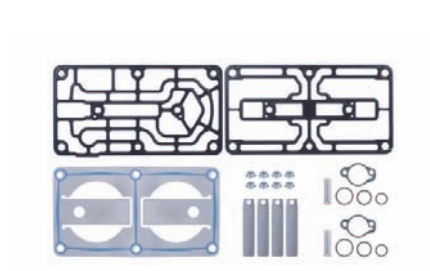

Valve Kit CK.246.906



Valve Kit CK.211.921



KNORR-BREMSE : K034874K50