

VOLVO



CB.101.000

 VOLVO
 1508996
 5001477

 KNORR-BREMSE
 286104
 TUFLO 501

VEHICLE APPLICATION

 F7 / FS7 / FL7
 B58 / N10 / F86
 F6 / F10 / F12

Cylinder Bore	Ø66.675 mm	Number of Cylinders	2	Water or Air Cooled	Water	Unloader Port Size	1/8" NPT
Stroke	38.10 mm	Air Inlet Port Size	-	Through Drive	Pulley	Water Inlet Port Size	1/2" NPT
Swept Volume	265 cm ³	Air Delivery Port Size	Ø22.50 mm	With ESS System	Yes	Water Delivery Port Size	1/2" NPT

Complete Cylinderhead

CB.101.100

BENDIX : 282070

Discharge Valve Seat Kit

CB.101.914

2 PCS PER SET



BENDIX : 794751

Inlet Valve Seat Kit

CB.101.915

2 PCS PER SET



BENDIX : 736118

Repair Kit

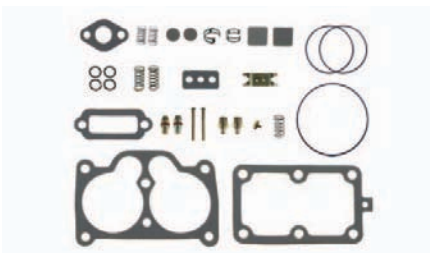
CB.101.903

Repair Kit

CB.101.912

BENDIX : 279615

Repair Kit

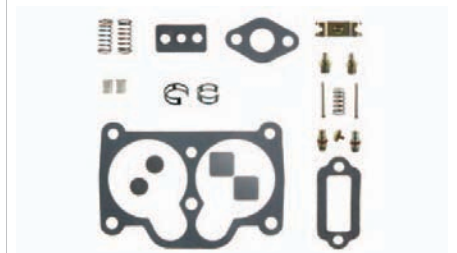
CB.101.913

BENDIX : 787043



<p>Piston & Ring</p> <p>66.68 mm CB.101.350</p> <p>66.93 mm CB.101.960</p> <p>67.18 mm CB.101.970</p>	<p>Piston</p> <p>66.68 mm CB.101.351</p> <p>66.93 mm CB.101.961</p> <p>67.18 mm CB.101.971</p>	<p>Ring</p> <p>66.68 mm CB.101.352</p> <p>66.93 mm CB.101.962</p> <p>67.18 mm CB.101.972</p>
<p>Crankcase</p> <p>CB.101.400</p> <p>BENDIX : 249360</p>	<p>Connecting Rod</p> <p>CB.101.500</p> <p>BENDIX : 286259</p>	<p>Connecting Rod Bearing</p> <p>CB.101.507</p>
<p>Crankshaft</p> <p>CB.101.601</p> <p>BENDIX : 246500</p>	<p>Flange Cover</p> <p>CB.103.720</p> <p>BENDIX : 290098A</p>	<p>Ball Bearing</p> <p>6207</p> <p>BENDIX : 236120</p>
<p>Bushing</p> <p>CB.101.708</p> <p>BENDIX : 246430</p>	<p>Rear Cover</p> <p>CB.101.720</p> <p>BENDIX : 245471</p>	<p>Sump Cover</p> <p>CB.101.751</p>

CB.102.000

 VOLVO
 1590649
 1594266
 5002295

 KNORR-BREMSE
 289257
 TUFLO 700

VEHICLE APPLICATION

 F7 / FS7 / FL7
 B58 / N10 / F86
 F6 / F10 / F12

Cylinder Bore	Ø69.85 mm	Number of Cylinders	2	Water or Air Cooled	Water	Unloader Port Size	1/8" NPT
Stroke	46.00 mm	Air Inlet Port Size	-	Through Drive	Pulley	Water Inlet Port Size	1/2" NPT
Swept Volume	352 cm ³	Air Delivery Port Size	Ø22.50 mm	With ESS System	Yes	Water Delivery Port Size	1/2" NPT

Complete Cylinderhead

CB.102.100

BENDIX : 292485

Discharge Valve Seat Kit

CB.101.914

2 PCS PER SET



BENDIX : 794751

Inlet Valve Seat Kit

CB.101.915

2 PCS PER SET



BENDIX : 736118

Repair Kit

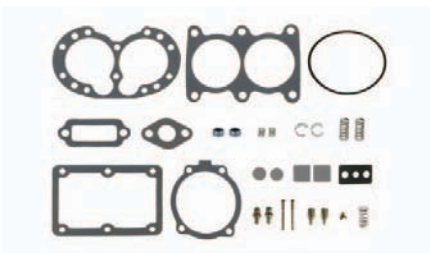
CB.102.903

Repair Kit

CB.101.912

BENDIX : 279615

Repair Kit

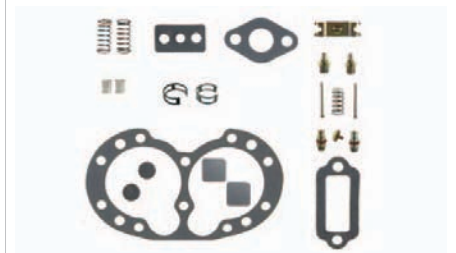
CB.102.913

BENDIX : 729417



Piston & Ring **69.85 mm** **CB.102.350**

70.10 mm **CB.102.960**

70.35 mm **CB.102.970**

Piston **69.85 mm** **CB.102.351**

70.10 mm **CB.102.961**

70.35 mm **CB.102.971**

Ring **69.85 mm** **CB.102.352**

70.10 mm **CB.102.962**

70.35 mm **CB.102.972**

Crankcase **CB.102.400**

BENDIX : 289697

Connecting Rod **CB.102.500**

BENDIX : 272720 / 289186

Connecting Rod Bearing **CB.108.507**

BENDIX : 238596 / 282767

Crankshaft **CB.102.601**

BENDIX : 292785

Cylinder Liner **CB.102.3010**

BENDIX : 238629

Ball Bearing **6207**

BENDIX : 236120

Ball Bearing **6011**

BENDIX : 235440

Rear Cover **CB.102.720**

BENDIX : 273228

Sump Cover **CB.102.751**

CB.103.000

 VOLVO
 1080437
 1612335
 1570594
 5001711
 1590264
 8112780
 1188844

 KNORR-BREMSE
 KZ433/1RM
 1186722

VEHICLE APPLICATION

 FL7 / FL10 / FL12
 F10 / F12 / F16
 NL10 / NL12
 B10 / B58

Cylinder Bore	Ø75.00	Number of Cylinders	2	Water or Air Cooled	Water	Unloader Port Size	-
Stroke	50 mm	Air Inlet Port Size	M26x1,5	Through Drive	Gear	Water Inlet Port Size	M16x1,5
Swept Volume	440 cm ³	Air Delivery Port Size	M26x1,5	With ESS System	-	Water Delivery Port Size	M16x1,5

Complete Cylinderhead

CB.103.100

Cylinder Head

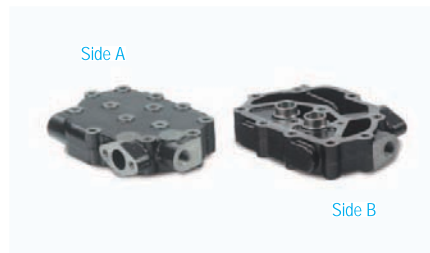
CB.103.1020

VOLVO : 3090472

Valve Plate

CB.103.1040

VOLVO : 3090473

Repair Kit

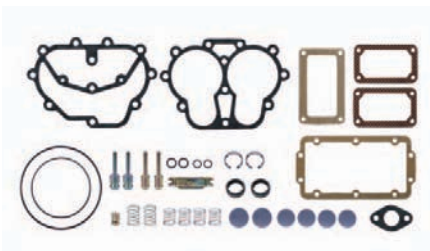
CB.103.903

Gasket Kit

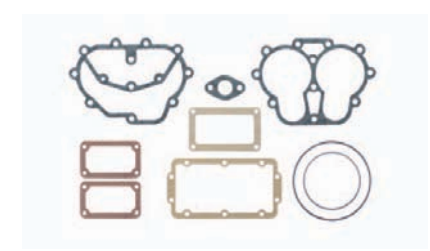
CB.103.905

Repair Kit

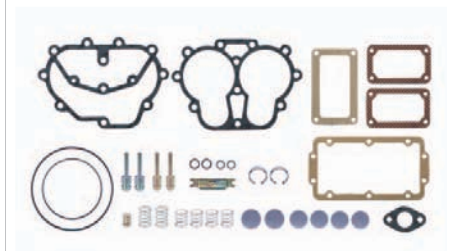
CB.103.912

 VOLVO : 3090471 / 272665 / 270698
 KNORR-BREMSE : I810150061



Piston & Ring 75.00 mm CB.103.350

2.38+2.38+3.94

75.25 mm CB.103.960

75.50 mm CB.103.970

VOLVO : 3094151

Piston 75.00 mm CB.103.351

75.25 mm CB.103.961

75.50 mm CB.103.971

VOLVO : 1697706

Ring 75.00 mm CB.103.352

2.38+2.38+3.94

75.25 mm CB.103.962

75.50 mm CB.103.972

VOLVO : 3094155

Crankcase **CB.103.400**

VOLVO : 3090257 / 1518356

Connecting Rod **CB.103.500**

VOLVO : 3090257 / 1518356

KNORR-BREMSE : KW3127-1

Crankshaft **CB.103.601**

VOLVO : 1518353

KNORR-BREMSE : KY1564-1

Bushing **CB.103.727**

39x35x25

VOLVO : 1518350

Rear Cover **CB.103.720**

Aluminum Bushing Cover

VOLVO : 3090239

KNORR-BREMSE : KY1223-11

Ball Bearing **6207**

VOLVO : 11014

Valve Seat Kit **CB.103.914**

VOLVO : 1518347

Full Repair Kit **CB.103.901**

CB.122.000

VOLVO
 9001611815
 1599919
 1611815
 5001153
 341453

KNORR-BREMSE
 280737
 TUFLO 500

VEHICLE APPLICATION

B58 / B55
 F7 / F10 / F12



Cylinder Bore	Ø63.50 mm	Number of Cylinders	2	Water or Air Cooled	Water	Unloader Port Size	1/8" NPT
Stroke	46.00 mm	Air Inlet Port Size	-	Through Drive	Pulley	Water Inlet Port Size	3/8" NPT
Swept Volume	292 cm ³	Air Delivery Port Size	Ø22.50 mm	With ESS System	Yes	Water Delivery Port Size	1/2" NPT

Complete Cylinderhead

CB.102.100

BENDIX : 292485

Discharge Valve Seat Kit

CB.101.914

2 PCS PER SET



BENDIX : 794751

Inlet Valve Seat Kit

CB.101.915

2 PCS PER SET



BENDIX : 736118

Repair Kit

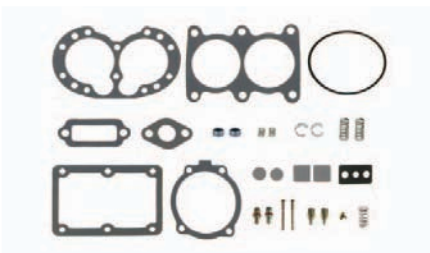
CB.102.903

Repair Kit

CB.101.912

BENDIX : 779615

Repair Kit

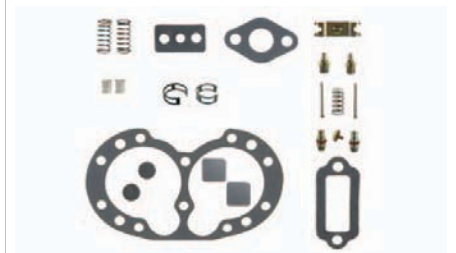
CB.102.913

BENDIX : 729417



Piston & Ring

63.50 mm CB.122.350

63.75 mm CB.122.960

64.00 mm CB.122.970

Piston

63.50 mm CB.122.351

63.75 mm CB.122.961

64.00 mm CB.122.971

Ring

63.50 mm CB.122.352

63.75 mm CB.122.962

64.00 mm CB.122.972

Crankcase

CB.102.400

BENDIX : 289697

Connecting Rod

CB.102.500

BENDIX : 272720 / 229084

Connecting Rod Bearing

CB.108.507

BENDIX : 238596 / 282767

Crankshaft

CB.102.601

BENDIX : 292785

Cylinder Liner

CB.122.3010

Ball Bearing

6207

BENDIX : 236120

Ball Bearing

6011

BENDIX : 235440

Rear Cover

CB.102.720

BENDIX : 273228

Sump Cover

CB.102.751

CK.106.000

 VOLVO
 8113633
 70305889
 70330081
 70330001
 85000194
 85000080
 8113565
 70303443

 KNORR-BREMSE
 LK4918
 LP4993

VEHICLE APPLICATION

 B10B / B10BLE
 B10L / B10LA
 B10M / B10MA

Cylinder Bore	Ø88.00	Number of Cylinders	2	Water or Air Cooled	Water	Unloader Port Size	-
Stroke	50 mm	Air Inlet Port Size	Ø29	Through Drive	Gear	Water Inlet Port Size	M16x1,5
Swept Volume	608 cm ³	Air Delivery Port Size	M26x1,5	With ESS System	-	Water Delivery Port Size	M16x1,5

Complete Cylinderhead

CK.106.1000

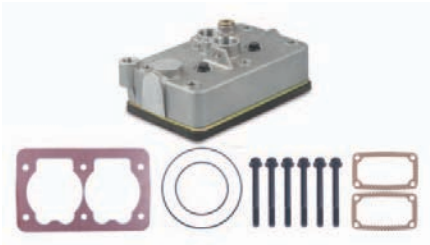

Cylinderhead

CK.106.1010

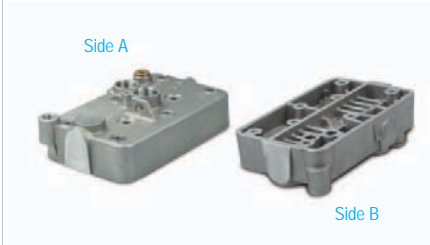
 LK4918 / LK4919 / LK4921 / LK4927 / LP4986 / LP4990
 LP4993 / LP4996 / LP4997

 VOLVO : 3095839
 KNORR-BREMSE : SEB01551004

Complete Valve Plate

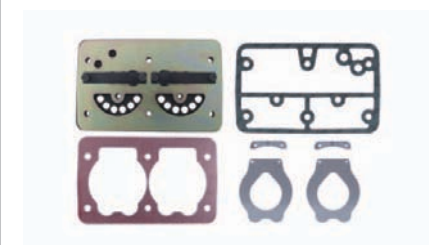
CK.106.200

 VOLVO : 3097146
 KNORR-BREMSE : SEB01033004

Valve Plate

CK.106.2010



Repair Kit

CK.106.903



KNORR-BREMSE : SEB22556

Repair Kit

CK.106.904





Piston & Ring 88.00 mm CK.116.350

2.50+2.50+4.00

88.25 mm CK.116.960

88.50 mm CK.116.970



VOLVO : 85101375 / 3095841 / 1698848
KNORR-BREMSE : SEB22555

Piston 88.00 mm CK.116.351

88.25 mm CK.116.961

88.50 mm CK.116.971



Ring 88.00 mm CK.116.352

2.50+2.50+4.00

88.25 mm CK.116.962

88.50 mm CK.116.972



VOLVO : 85100626 / 3097153
KNORR-BREMSE : II39526F0061

Crankcase CK.106.400



Connecting Rod CK.116.500



VOLVO : 3097151
KNORR-BREMSE : SEB00967004

Crankshaft CK.116.601



Bushing CK.116.434

42x38x25



VOLVO : 1697278 / 1697286
KNORR-BREMSE : EB00819

Rear Cover CK.116.720

Aluminum Bushing Cover



VOLVO : 3097150
KNORR-BREMSE : II159920065

Gasket Kit CK.106.905



VOLVO : 3095840
KNORR-BREMSE : SEB22557

Valve Kit CK.106.906



Repair Kit CK.106.910



Nut MC202061FX

M20x1.5 Right Hand



VOLVO : 1698672

CK.108.000

 VOLVO
 1599999
 5003217

 KNORR-BREMSE
 LP4812
 I86909

VEHICLE APPLICATION

 B6 / B7 / B10 / B12
 F16
 FL10 / FL6 / FL7
 FS7

Cylinder Bore	Ø75.00	Number of Cylinders	2	Water or Air Cooled	Water	Unloader Port Size	-
Stroke	50 mm	Air Inlet Port Size	M26x1,5	Through Drive	Gear	Water Inlet Port Size	M16x1,5
Swept Volume	440 cm ³	Air Delivery Port Size	M26x1,5	With ESS System	-	Water Delivery Port Size	M16x1,5

Complete Cylinderhead

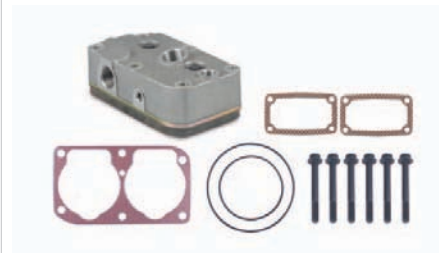
CK.108.1000

Cylinderhead

CK.108.1010

 VOLVO : 1697771
 KNORR-BREMSE : SEB00421004

Complete Valve Plate

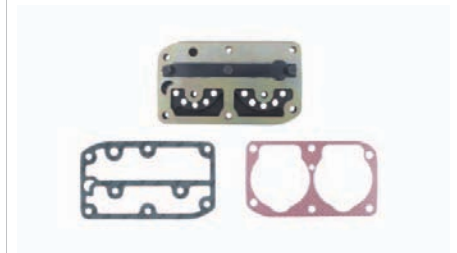
CK.108.200

 VOLVO : 1697770 / 1697290
 KNORR-BREMSE : I81015004

Valve Plate

CK.108.2010

Repair Kit

CK.108.903

KNORR-BREMSE : SEB22541

Repair Kit

CK.108.904





Piston & Ring 75.00 mm CK.108.350

2.00+2.00+4.00

75.25 mm CK.108.960

75.50 mm CK.108.970



VOLVO : 1697282
KNORR-BREMSE : SEB22539 / SEB22540

Piston 75.00 mm CK.108.351

75.25 mm CK.108.961

75.50 mm CK.108.971



Ring 75.00 mm CW.108.352

2.00+2.00+4.00

75.25 mm CW.108.962

75.50 mm CW.108.972



VOLVO : 3090388
KNORR-BREMSE : I801770061

Crankcase CK.108.400



Connecting Rod CK.108.500



VOLVO : 1697281 / 1698528 / 3090386
KNORR-BREMSE : SEB00626004 / SEB00957004

Crankshaft CK.108.601



VOLVO : 1697285
KNORR-BREMSE : EB007622V / EB00762

Bushing CK.116.434

42x38x25



VOLVO : 1697278 / 1697286
KNORR-BREMSE : EB00819

Rear Cover CK.108.720

Aluminum Bushing Cover



VOLVO : 3090385 / 1697769
KNORR-BREMSE : SEB00387004

Gasket Kit CK.108.905



KNORR-BREMSE : SEB22542

Valve Kit CK.108.906



KNORR-BREMSE : II326840061

Repair Kit CK.108.911



Nut MC202061FX



VOLVO : 1698672

CK.109.000

 VOLVO
 1613632
 5003336

 KNORR-BREMSE
 LP4813
 I90499

VEHICLE APPLICATION

 B6 / B7 / B10 / B12
 F16
 FL10 / FL6 / FL7
 FS7

Cylinder Bore	Ø75.00	Number of Cylinders	2	Water or Air Cooled	Water	Unloader Port Size	-
Stroke	50 mm	Air Inlet Port Size	M26x1,5	Through Drive	Gear	Water Inlet Port Size	M16x1,5
Swept Volume	440 cm ³	Air Delivery Port Size	M26x1,5	With ESS System	-	Water Delivery Port Size	M16x1,5

Complete Cylinderhead

CK.109.1000

Cylinderhead

CK.109.1010



Complete Valve Plate

CK.108.200

Valve Plate

CK.108.2010

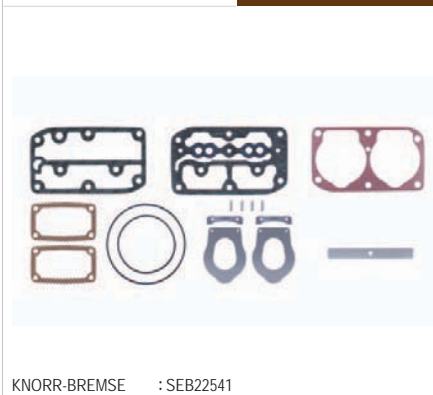
Repair Kit

CK.108.903

Repair Kit

CK.108.904





Piston & Ring 75.00 mm CK.108.350

2.00+2.00+4.00

75.25 mm CK.108.960

75.50 mm CK.108.970



VOLVO : 1697282
KNORR-BREMSE : SEB22539 / SEB22540

Piston 75.00 mm CK.108.351

75.25 mm CK.108.961

75.50 mm CK.108.971



Ring 75.00 mm CW.108.352

2.00+2.00+4.00

75.25 mm CW.108.962

75.50 mm CW.108.972



VOLVO : 3090388
KNORR-BREMSE : I801770061

Crankcase CK.108.400



Connecting Rod CK.108.500



VOLVO : 1697281 / 1698528 / 3090386
KNORR-BREMSE : SEB00626004 / SEB00957004

Crankshaft CK.108.601



VOLVO : 1697285
KNORR-BREMSE : EB007622V / EB00762

Bushing CK.116.434

42x38x25



VOLVO : 1697278 / 1697286
KNORR-BREMSE : EB00819

Rear Cover CK.108.720

Aluminum Bushing Cover



VOLVO : 3090385 / 1697769
KNORR-BREMSE : SEB00387004

Gasket Kit CK.108.905



KNORR-BREMSE : SEB22542

Valve Kit CK.108.906



KNORR-BREMSE : II326840061

Repair Kit CK.108.911



Nut MC202061FX



VOLVO : 1698672

CK.112.000

 VOLVO
 8150407
 8112427

 KNORR-BREMSE
 LP4825
 II15993

VEHICLE APPLICATION

 FL10
 FL12
 F12
 F16
 FL6
 NL10
 NL12
 B10M
 B58

Cylinder Bore	Ø75.00	Number of Cylinders	2	Water or Air Cooled	Water	Unloader Port Size	M22x1,5
Stroke	50 mm	Air Inlet Port Size	M26x1,5	Through Drive	Gear	Water Inlet Port Size	M16x1,5
Swept Volume	440 cm ³	Air Delivery Port Size	M26x1,5	With ESS System	Yes	Water Delivery Port Size	M16x1,5

Complete Cylinderhead

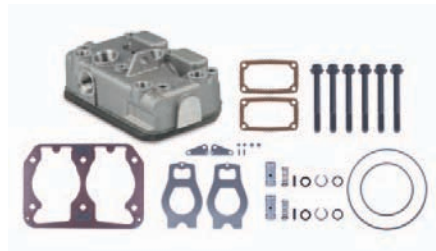
CK.112.1000

Cylinderhead

CK.112.1010

 VOLVO : 3090378
 KNORR-BREMSE : SEB01080004

Complete Valve Plate

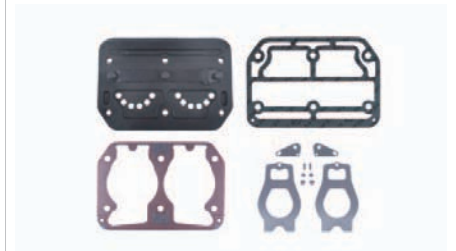
CK.112.200

 VOLVO : 3090380
 KNORR-BREMSE : SEB01081004

Valve Plate

CK.112.2010

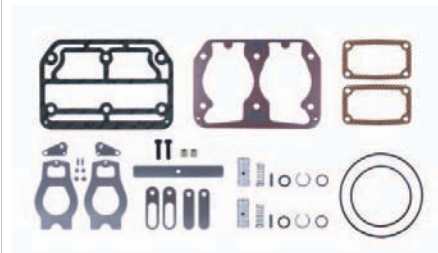
Repair Kit

CK.112.903

Repair Kit

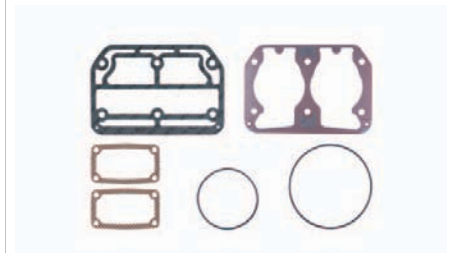
CK.112.905

 VOLVO : 3090377
 KNORR-BREMSE : II159930051



Piston & Ring 75.00 mm CK.108.350

2.00+2.00+4.00

75.25 mm CK.108.960

75.50 mm CK.108.970

VOLVO : 1697282
KNORR-BREMSE : SEB22539 / SEB22540

Piston 75.00 mm CK.108.351

75.25 mm CK.108.961

75.50 mm CK.108.971

Ring 75.00 mm CW.108.352

2.00+2.00+4.00

75.25 mm CW.108.962

75.50 mm CW.108.972

VOLVO : 3090388
KNORR-BREMSE : I801770061

Crankcase CK.112.400

Connecting Rod CK.108.500

VOLVO : 1697281 / 1698528 / 3090386
KNORR-BREMSE : SEB00626004 / SEB00957004

Crankshaft CK.108.601

VOLVO : 1697285
KNORR-BREMSE : EB007622V / EB00762

Bushing CK.116.434

42x38x25

VOLVO : 1697278 / 1697286
KNORR-BREMSE : EB00819

Rear Cover CK.108.720

Aluminum Bushing Cover

VOLVO : 3090385 / 1697769
KNORR-BREMSE : SEB00387004

Valve Kit CK.112.907

VOLVO : 3091740
KNORR-BREMSE : I1326850061

Valve Kit CK.112.908

VOLVO : 3091591
KNORR-BREMSE : SEB010800061

Repair Kit CK.112.912

Repair Kit CK.116.921

VOLVO : 3097147
KNORR-BREMSE : I1159920063

CK.113.000

 VOLVO
 1628593
 8112594

 KNORR-BREMSE
 LP4930
 II15698

VEHICLE APPLICATION

 FH12
 FM16
 NH12
 B12

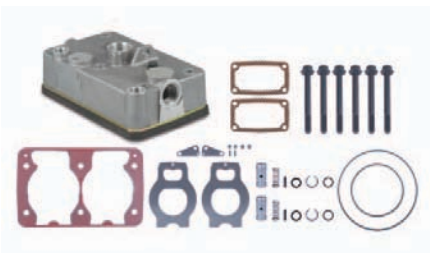

Cylinder Bore	Ø88.00	Number of Cylinders	2	Water or Air Cooled	Water	Unloader Port Size	M22x1,5
Stroke	50 mm	Air Inlet Port Size	Ø29	Through Drive	Gear	Water Inlet Port Size	M16x1,5
Swept Volume	608 cm ³	Air Delivery Port Size	M26x1,5	With ESS System	Yes	Water Delivery Port Size	M16x1,5

Complete Cylinderhead

CK.117.1000

KNORR-BREMSE : SEB05052004

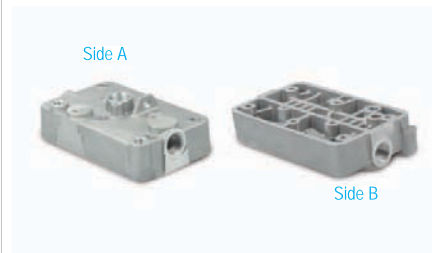
Cylinderhead

CK.117.1010

 VOLVO : 1699820
 KNORR-BREMSE : SEB01138004

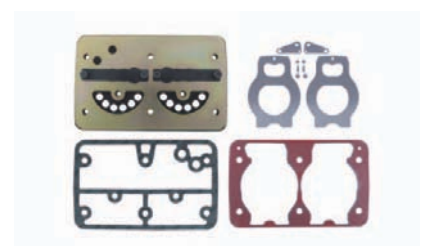
Complete Valve Plate

CK.116.200

 VOLVO : 3097146
 KNORR-BREMSE : SEB01033004

Valve Plate

CK.116.2010

Repair Kit

CK.116.903

Repair Kit

CK.116.905



Piston & Ring 88.00 mm CK.116.350

2.50+2.50+4.00

88.25 mm CK.116.960

88.50 mm CK.116.970

VOLVO : 85101375 / 3095841 / 1698848
 KNORR-BREMSE : SEB22555

Piston 88.00 mm CK.116.351

88.25 mm CK.116.961

88.50 mm CK.116.971

Ring 88.00 mm CK.116.352

2.50+2.50+4.00

88.25 mm CK.116.962

88.50 mm CK.116.972

VOLVO : 85100626 / 3097153
 KNORR-BREMSE : II39526F0061

Crankcase CK.113.400

Connecting Rod CK.116.500

VOLVO : 3097151
 KNORR-BREMSE : SEB00967004

Crankshaft CK.117.601

Bushing CK.116.434

42x38x25

VOLVO : 1697278 / 1697286
 KNORR-BREMSE : EB00819

Rear Cover CK.116.720

Aluminum Bushing Cover

VOLVO : 3097150
 KNORR-BREMSE : II159920065

Valve Kit CK.116.907

VOLVO : 3091739
 KNORR-BREMSE : II326840061

Valve Kit CK.116.908

VOLVO : 3091718
 KNORR-BREMSE : SEB01138004 / SEB011380061

Repair Kit CK.116.912

Repair Kit CK.116.921

VOLVO : 3097147
 KNORR-BREMSE : II159920063

CK.114.000

 VOLVO
 3037346
 8112543

 KNORR-BREMSE
 LP4934
 II15992

VEHICLE APPLICATION

 B10B
 B10L
 B10M
 B10BLE
 B10LA

Cylinder Bore	Ø88.00	Number of Cylinders	2	Water or Air Cooled	Water	Unloader Port Size	M22x1,5
Stroke	50 mm	Air Inlet Port Size	Ø29	Through Drive	Gear	Water Inlet Port Size	M16x1,5
Swept Volume	608 cm ³	Air Delivery Port Size	M26x1,5	With ESS System	Yes	Water Delivery Port Size	M16x1,5

Complete Cylinderhead

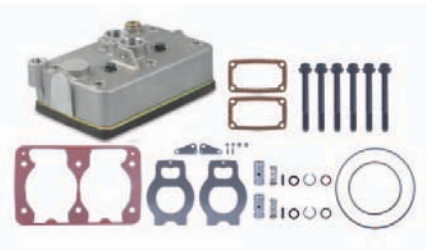
CK.116.1000

Cylinderhead

CK.116.1010

FIT LP4934 / LP4949 / LP4960 / LP4967 / LP4968

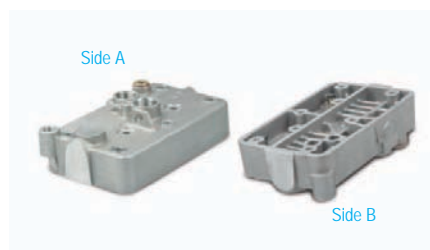
 VOLVO : 3097144
 KNORR-BREMSE : SEB01052004

Complete Valve Plate

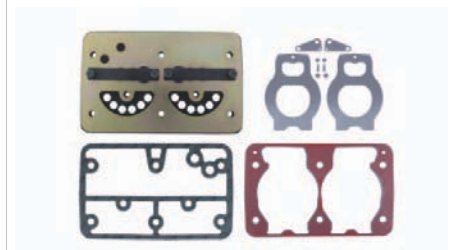
CK.116.200

 VOLVO : 3097146
 KNORR-BREMSE : SEB01033004

Valve Plate

CK.116.2010

Repair Kit

CK.116.903

Repair Kit

CK.116.905





Piston & Ring 88.00 mm CK.116.350

2.50+2.50+4.00

88.25 mm CK.116.960

88.50 mm CK.116.970



VOLVO : 85101375 / 3095841 / 1698848
 KNORR-BREMSE : SEB22555

Piston 88.00 mm CK.116.351

88.25 mm CK.116.961

88.50 mm CK.116.971



Ring 88.00 mm CK.116.352

2.50+2.50+4.00

88.25 mm CK.116.962

88.50 mm CK.116.972



VOLVO : 85100626 / 3097153
 KNORR-BREMSE : II39526F0061

Crankcase **CK.114.400**



Connecting Rod **CK.116.500**



VOLVO : 3097151
 KNORR-BREMSE : SEB00967004

Crankshaft **CK.116.601**



Bushing **CK.116.434**

42x38x25



VOLVO : 1697278 / 1697286
 KNORR-BREMSE : EB00819

Rear Cover **CK.116.720**

Aluminum Bushing Cover



VOLVO : 3097150
 KNORR-BREMSE : II159920065

Valve Kit **CK.116.907**



VOLVO : 3091739
 KNORR-BREMSE : II326840061

Valve Kit **CK.116.908**



VOLVO : 3091718
 KNORR-BREMSE : SEB01138004 / SEB011380061

Repair Kit **CK.116.912**



Repair Kit **CK.116.921**



VOLVO : 3097147
 KNORR-BREMSE : II159920063

CK.116.000

 VOLVO
 8113023
 9521675

 KNORR-BREMSE
 LP4967
 II33164

VEHICLE APPLICATION

 B10B
 B10L
 B10M

Cylinder Bore	Ø88.00	Number of Cylinders	2	Water or Air Cooled	Water	Unloader Port Size	M22x1,5
Stroke	50 mm	Air Inlet Port Size	Ø29	Through Drive	Gear	Water Inlet Port Size	M16x1,5
Swept Volume	608 cm ³	Air Delivery Port Size	M26x1,5	With ESS System	Yes	Water Delivery Port Size	M16x1,5

Complete Cylinderhead

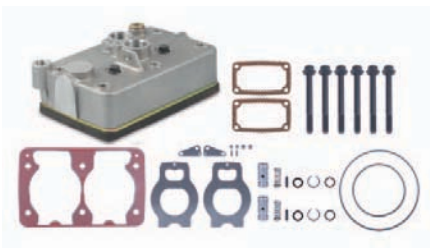
CK.116.1000

Cylinderhead

CK.116.1010

FIT LP4934 / LP4949 / LP4960 / LP4967 / LP4968

 VOLVO : 3097144
 KNORR-BREMSE : SEB01052004

Complete Valve Plate

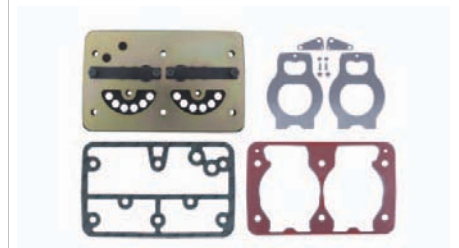
CK.116.200

 VOLVO : 3097146
 KNORR-BREMSE : SEB01033004

Valve Plate

CK.116.2010

Repair Kit

CK.116.903

Repair Kit

CK.116.905





Piston & Ring 88.00 mm CK.116.350

2.50+2.50+4.00

88.25 mm CK.116.960

88.50 mm CK.116.970



VOLVO : 85101375 / 3095841 / 1698848
KNORR-BREMSE : SEB22555

Piston 88.00 mm CK.116.351

88.25 mm CK.116.961

88.50 mm CK.116.971



Ring 88.00 mm CK.116.352

2.50+2.50+4.00

88.25 mm CK.116.962

88.50 mm CK.116.972



VOLVO : 85100626 / 3097153
KNORR-BREMSE : II39526F0061

Crankcase CK.116.400



Connecting Rod CK.116.500



VOLVO : 3097151
KNORR-BREMSE : SEB00967004

Crankshaft CK.116.601



Bushing CK.116.434

42x38x25



VOLVO : 1697278 / 1697286
KNORR-BREMSE : EB00819

Rear Cover CK.116.720

Aluminum Bushing Cover



VOLVO : 3097150
KNORR-BREMSE : II159920065

Valve Kit CK.116.907



VOLVO : 3091739
KNORR-BREMSE : II326840061

Valve Kit CK.116.908



VOLVO : 3091718
KNORR-BREMSE : SEB01138004 / SEB011380061

Repair Kit CK.116.912



Repair Kit CK.116.921



VOLVO : 3097147
KNORR-BREMSE : II159920063

CK.117.000

 VOLVO
 20429339
 3987602
 85000064

 KNORR-BREMSE
 LP4974
 II37214

VEHICLE APPLICATION

 FH12
 FM16
 NH12
 B12

Cylinder Bore	Ø88.00	Number of Cylinders	2	Water or Air Cooled	Water	Unloader Port Size	M22x1,5
Stroke	50 mm	Air Inlet Port Size	Ø29	Through Drive	Gear	Water Inlet Port Size	M16x1,5
Swept Volume	608 cm ³	Air Delivery Port Size	M26x1,5	With ESS System	Yes	Water Delivery Port Size	M16x1,5

Complete Cylinderhead

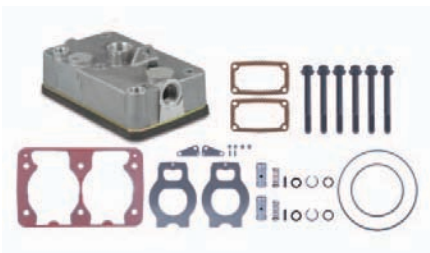
CK.117.1000

KNORR-BREMSE : SEB05052004

Cylinderhead

CK.117.1010

 VOLVO : 1699820
 KNORR-BREMSE : SEB01138004

Complete Valve Plate

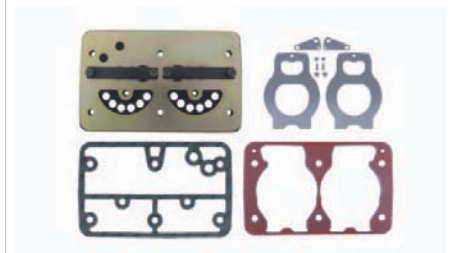
CK.116.200

 VOLVO : 3097146
 KNORR-BREMSE : SEB01033004

Valve Plate

CK.116.2010

Repair Kit

CK.116.903

Repair Kit

CK.116.905





Piston & Ring 88.00 mm CK.116.350

2.50+2.50+4.00

88.25 mm CK.116.960

88.50 mm CK.116.970



VOLVO : 85101375 / 3095841 / 1698848
KNORR-BREMSE : SEB22555

Piston 88.00 mm CK.116.351

88.25 mm CK.116.961

88.50 mm CK.116.971



Ring 88.00 mm CK.116.352

2.50+2.50+4.00

88.25 mm CK.116.962

88.50 mm CK.116.972



VOLVO : 85100626 / 3097153
KNORR-BREMSE : II39526F0061

Crankcase CK.117.400



Connecting Rod CK.116.500



VOLVO : 3097151
KNORR-BREMSE : SEB00967004

Crankshaft CK.117.601



Bushing CK.116.434

42x38x25



VOLVO : 1697278 / 1697286
KNORR-BREMSE : EB00819

Rear Cover CK.116.720

Aluminum Bushing Cover



VOLVO : 3097150
KNORR-BREMSE : II159920065

Valve Kit CK.116.907



VOLVO : 3091739
KNORR-BREMSE : II326840061

Valve Kit CK.116.908



VOLVO : 3091718
KNORR-BREMSE : SEB01138004 / SEB011380061

Repair Kit CK.116.912



Repair Kit CK.116.921



VOLVO : 3097147
KNORR-BREMSE : II159920063

CK.118.000

 VOLVO
 70330098
 85000199
 8113592
 70305894
 70330006
 85000085

 KNORR-BREMSE
 LP4992

VEHICLE APPLICATION

 FH12 / FH16
 FM7 / FM12
 NH12 / FL12
 B12 / B12B
 B12R / B7L

Cylinder Bore	Ø88.00	Number of Cylinders	2	Water or Air Cooled	Water	Unloader Port Size	-
Stroke	50 mm	Air Inlet Port Size	Ø29	Through Drive	Gear	Water Inlet Port Size	M16x1,5
Swept Volume	608 cm ³	Air Delivery Port Size	M26x1,5	With ESS System	-	Water Delivery Port Size	M16x1,5

Complete Cylinderhead

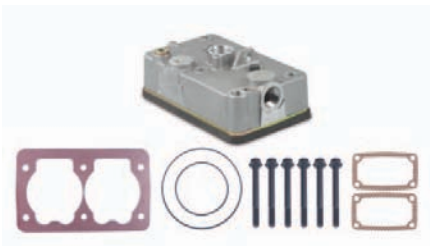
CK.118.1000

Cylinderhead

CK.118.1010

LK4920 / LP4985 / LP4988 / LP4991 / LP4992 / LP4995

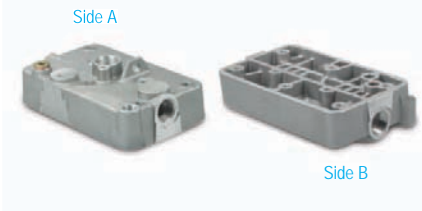
 VOLVO : 3095847
 KNORR-BREMSE : SEB01549004

Complete Valve Plate

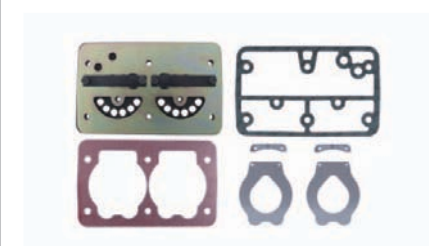
CK.106.200

 VOLVO : 3097146
 KNORR-BREMSE : SEB01033004

Valve Plate

CK.106.2010

Repair Kit

CK.106.903

KNORR-BREMSE : SEB22556

Repair Kit

CK.106.904





Piston & Ring 88.00 mm CK.116.350

2.50+2.50+4.00

88.25 mm CK.116.960

88.50 mm CK.116.970



VOLVO : 85101375 / 3095841 / 1698848
 KNORR-BREMSE : SEB22555

Piston 88.00 mm CK.116.351

88.25 mm CK.116.961

88.50 mm CK.116.971



Ring 88.00 mm CK.116.352

2.50+2.50+4.00

88.25 mm CK.116.962

88.50 mm CK.116.972



VOLVO : 85100626 / 3097153
 KNORR-BREMSE : II39526F0061

Crankcase CK.118.400



Connecting Rod CK.116.500



VOLVO : 3097151
 KNORR-BREMSE : SEB00967004

Crankshaft CK.117.601



Bushing CK.116.434

42x38x25



VOLVO : 1697278 / 1697286
 KNORR-BREMSE : EB00819

Rear Cover CK.116.720

Aluminum Bushing Cover



VOLVO : 3097150
 KNORR-BREMSE : II159920065

Gasket Kit CK.106.905



VOLVO : 3095840
 KNORR-BREMSE : SEB22557

Valve Kit CK.106.906



Repair Kit CK.106.910



Nut MC202061FX

M20x1.5 Right Hand



VOLVO : 1698672

CK.121.000

 VOLVO
 20429343
 3173001
 8113405
 85000066

 KNORR-BREMSE
 LP4985
 II37760

VEHICLE APPLICATION

 FH12 / FH16
 FM7 / FM12
 NH12 / FL12
 B12 / B12B
 B12R / B7L

Cylinder Bore	Ø88.00	Number of Cylinders	2	Water or Air Cooled	Water	Unloader Port Size	-
Stroke	50 mm	Air Inlet Port Size	Ø29	Through Drive	Gear	Water Inlet Port Size	M16x1,5
Swept Volume	608 cm ³	Air Delivery Port Size	M26x1,5	With ESS System	-	Water Delivery Port Size	M16x1,5

Complete Cylinderhead

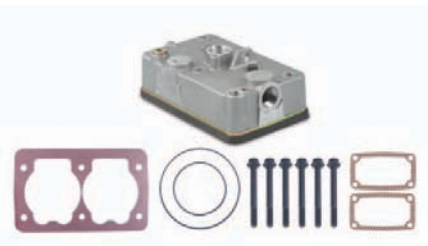
CK.118.1000

Cylinderhead

CK.118.1010

LK4920 / LP4985 / LP4988 / LP4991 / LP4992 / LP4995

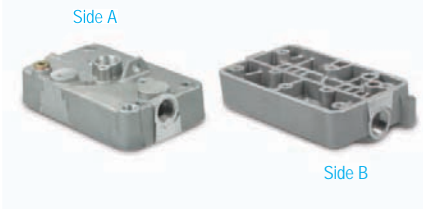
 VOLVO : 3095847
 KNORR-BREMSE : SEB01549004

Complete Valve Plate

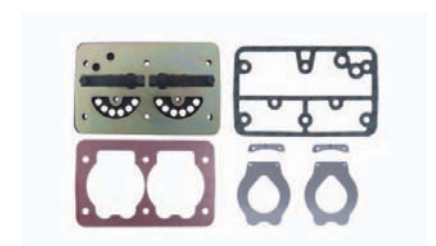
CK.106.200

 VOLVO : 3097146
 KNORR-BREMSE : SEB01033004

Valve Plate

CK.106.2010

Repair Kit

CK.106.903

KNORR-BREMSE : SEB22556

Repair Kit

CK.106.904





Piston & Ring 88.00 mm CK.116.350

2.50+2.50+4.00

88.25 mm CK.116.960

88.50 mm CK.116.970



VOLVO : 85101375 / 3095841 / 1698848
 KNORR-BREMSE : SEB22555

Piston 88.00 mm CK.116.351

88.25 mm CK.116.961

88.50 mm CK.116.971



Ring 88.00 mm CK.116.352

2.50+2.50+4.00

88.25 mm CK.116.962

88.50 mm CK.116.972



VOLVO : 85100626 / 3097153
 KNORR-BREMSE : II39526F0061

Crankcase CK.118.400



Connecting Rod CK.116.500



VOLVO : 3097151
 KNORR-BREMSE : SEB00967004

Crankshaft CK.117.601



Bushing CK.116.434

42x38x25



VOLVO : 1697278 / 1697286
 KNORR-BREMSE : EB00819

Rear Cover CK.116.720

Aluminum Bushing Cover



VOLVO : 3097150
 KNORR-BREMSE : II159920065

Gasket Kit CK.106.905



VOLVO : 3095840
 KNORR-BREMSE : SEB22557

Valve Kit CK.106.906



Repair Kit CK.106.910



Nut MC202061FX

M20x1.5 Right Hand



VOLVO : 1698672

CK.127.000

VOLVO
 8113634
 70305892
 70330094
 85000197
 85000083
 70330004
 8113567
 70303446
 8113484
 3194908

KNORR-BREMSE
 LK4921
 LP4996
 LP4989

VEHICLE APPLICATION

B10M / B10R / B10
 B12 / B6BLE
 SUPER OLYPIAN



Cylinder Bore	Ø88.00	Number of Cylinders	2	Water or Air Cooled	Water	Unloader Port Size	-
Stroke	50 mm	Air Inlet Port Size	Ø29	Through Drive	Gear	Water Inlet Port Size	M16x1,5
Swept Volume	608 cm ³	Air Delivery Port Size	M26x1,5	With ESS System	-	Water Delivery Port Size	M16x1,5

Complete Cylinderhead

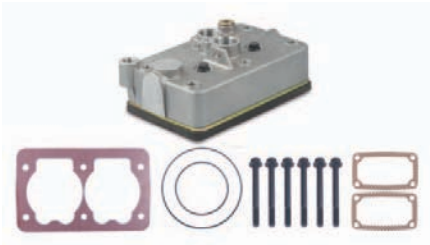
CK.106.1000

Cylinderhead

CK.106.1010

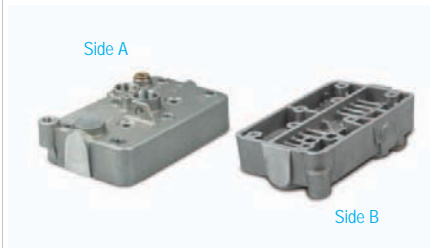
 LK4918 / LK4919 / LK4921 / LK4927 / LP4986 / LP4990
 LP4993 / LP4996 / LP4997

VOLVO : 3095839
 KNORR-BREMSE : SEB01551004

Complete Valve Plate

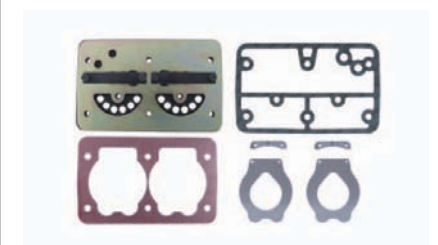
CK.106.200

VOLVO : 3097146
 KNORR-BREMSE : SEB01033004

Valve Plate

CK.106.2010

Repair Kit

CK.106.903

KNORR-BREMSE : SEB22556

Repair Kit

CK.106.904



Piston & Ring 88.00 mm CK.116.350

2.50+2.50+4.00

88.25 mm CK.116.960

88.50 mm CK.116.970

VOLVO : 85101375 / 3095841 / 1698848
 KNORR-BREMSE : SEB22555

Piston 88.00 mm CK.116.351

88.25 mm CK.116.961

88.50 mm CK.116.971

Ring 88.00 mm CK.116.352

2.50+2.50+4.00

88.25 mm CK.116.962

88.50 mm CK.116.972

VOLVO : 85100626 / 3097153
 KNORR-BREMSE : II39526F0061

Crankcase CK.127.400

Connecting Rod CK.116.500

VOLVO : 3097151
 KNORR-BREMSE : SEB00967004

Crankshaft CK.116.601

Bushing CK.116.434

42x38x25

VOLVO : 1697278 / 1697286
 KNORR-BREMSE : EB00819

Rear Cover CK.116.720

Aluminum Bushing Cover

VOLVO : 3097150
 KNORR-BREMSE : II159920065

Gasket Kit CK.106.905

VOLVO : 3095840
 KNORR-BREMSE : SEB22557

Valve Kit CK.106.906

Repair Kit CK.106.910

Nut MC202061FX

M20x1.5 Right Hand

VOLVO : 1698672

CK.132.000

 VOLVO
 8129779
 8113270
 8119270

 KNORR-BREMSE
 LP4850
 II35564

VEHICLE APPLICATION

 FL6
 FL7
 FL10

Cylinder Bore	Ø75.00	Number of Cylinders	2	Water or Air Cooled	Water	Unloader Port Size	-
Stroke	50 mm	Air Inlet Port Size	M26x1,5	Through Drive	Gear	Water Inlet Port Size	M16x1,5
Swept Volume	440 cm ³	Air Delivery Port Size	M26x1,5	With ESS System	-	Water Delivery Port Size	M16x1,5

Complete Cylinderhead

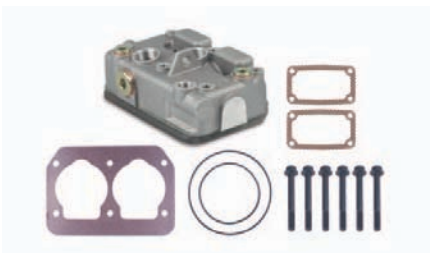
CK.132.1000

Cylinderhead

CK.132.1010

 VOLVO : 8127749
 KNORR-BREMSE : SEB0515004

Complete Valve Plate

CK.132.200

 VOLVO : 8127751
 KNORR-BREMSE : SEB01000004

Valve Plate

CK.132.2010

Repair Kit

CK.132.903

Repair Kit

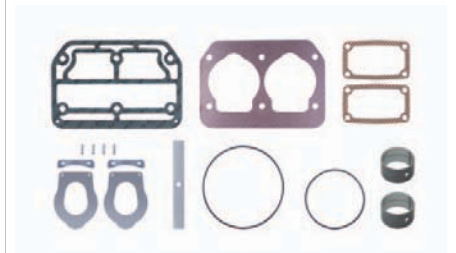
CK.132.904





Piston & Ring 75.00 mm CK.108.350

2.00+2.00+4.00

75.25 mm CK.108.960

75.50 mm CK.108.970



VOLVO : 1697282
KNORR-BREMSE : SEB22539 / SEB22540

Piston 75.00 mm CK.108.351

75.25 mm CK.108.961

75.50 mm CK.108.971



Ring 75.00 mm CW.108.352

2.00+2.00+4.00

75.25 mm CW.108.962

75.50 mm CW.108.972



VOLVO : 3090388
KNORR-BREMSE : I801770061

Crankcase CK.132.400



Connecting Rod CK.108.500



VOLVO : 1697281 / 1698528 / 3090386
KNORR-BREMSE : SEB00626004 / SEB00957004

Crankshaft CK.108.601



VOLVO : 1697285
KNORR-BREMSE : EB007622V / EB00762

Bushing CK.116.434

42x38x25



VOLVO : 1697278 / 1697286
KNORR-BREMSE : EB00819

Rear Cover CK.108.720

Aluminum Bushing Cover



VOLVO : 3090385 / 1697769
KNORR-BREMSE : SEB00387004

Gasket Kit CK.132.905



VOLVO : 8127750
KNORR-BREMSE : II156970051 / SEB22544

Valve Kit CK.108.906



KNORR-BREMSE : II326840061

Repair Kit CK.132.911



Nut MC202061FX



VOLVO : 1698672

CK.149.000

WABCO CYLINDER HEAD VERION

CK.278.000

KNORR-BREMSE CYLINDER HEAD VERION

 VOLVO
 6772239
 5003219
 085028

 KNORR-BREMSE
 LK3802
 I85028
VEHICLE APPLICATION
 F7
 FL7
**CK.149.000****CK.278.000**

*** CK.149.000 - WABCO Cylinder Head Version

*** CK.278.000 - KNORR-BREMSE Cylinder Head Version

Cylinder Bore	Ø88.00	Number of Cylinders	1	Water or Air Cooled	Water	Unloader Port Size	-
Stroke	35 mm	Air Inlet Port Size	M26x1,5	Through Drive	Gear	Water Inlet Port Size	-
Swept Volume	213 cm ³	Air Delivery Port Size	M26x1,5	With ESS System	-	Water Delivery Port Size	-

Complete Cylinderhead

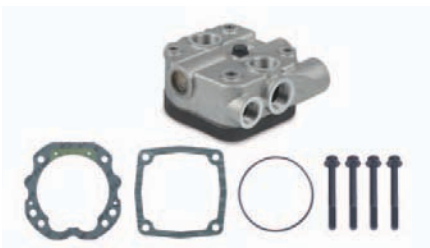
CK.149.100

WABCO : 411 033 806 2 / 411 033 801 2

Cylinderhead

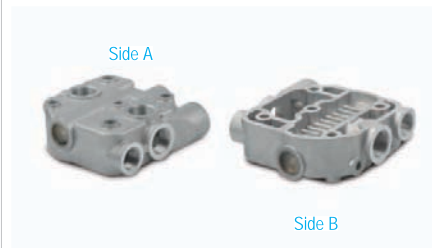
CK.149.1010

WABCO : 411 033 653 2

Complete Valve Plate

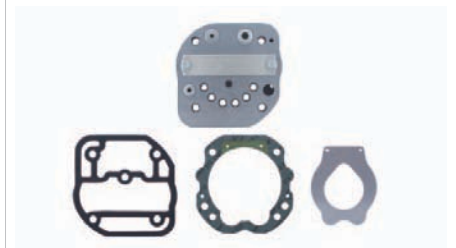
CK.149.200

WABCO : 411 033 505 2 / 411 033 503 2

Complete Cylinderhead

CK.278.100

KNORR-BREMSE : I90153004 / I93078004

Cylinderhead

CK.278.1010

KNORR-BREMSE : STW63970 / ZB4275

Complete Valve Plate

CK.278.200

KNORR-BREMSE : I880570061 / I38715F004



Piston & Ring 88.00 mm CK.116.350

88.25 mm CK.116.960

88.50 mm CK.116.970

KNORR-BREMSE : SEB2555

Piston 88.00 mm CK.116.351

88.25 mm CK.116.961

88.50 mm CK.116.971

Ring 88.00 mm CW.116.352

2.00+2.00+4.00

88.25 mm CW.116.962

88.50 mm CW.116.972

Crankcase CK.149.400

Connecting Rod CK.102.500

VOLVO : 1698852
KNORR-BREMSE : B80110 / I60599

Crankshaft CK.149.601

VOLVO : 1697094
KNORR-BREMSE : I85022

Cylinder Liner & Piston CK.130.300

STD. Piston & Ring

KNORR-BREMSE : I80864/0061

Cylinder Liner CK.130.3010

VOLVO : 1697111
KNORR-BREMSE : C63059

Flange Cover CK.149.700

VOLVO : 1687207
KNORR-BREMSE : I80962

Bushing CK.102.708

34x30x16

KNORR-BREMSE : B64572

Repair Kit CK.149.903

Repair Kit CK.278.903

CK.172.000

 VOLVO
 6795600
 5003219

 KNORR-BREMSE
 LK3813
 I94314

VEHICLE APPLICATION

 F7
 FL7

Cylinder Bore	Ø88.00	Number of Cylinders	1	Water or Air Cooled	Water	Unloader Port Size	-
Stroke	37 mm	Air Inlet Port Size	M26x1,5	Through Drive	Gear	Water Inlet Port Size	-
Swept Volume	225 cm ³	Air Delivery Port Size	M26x1,5	With ESS System	-	Water Delivery Port Size	-

Complete Cylinderhead

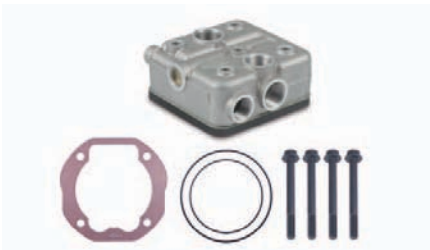
CK.172.100

 VOLVO : 1698851
 KNORR-BREMSE : K021494K50

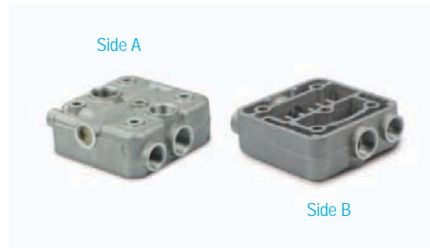
Cylinderhead

CK.172.1010

KNORR-BREMSE : I94672

Complete Valve Plate

CK.172.200

 VOLVO : 276117 / 3099753
 KNORR-BREMSE : I94056004

Valve Plate

CK.172.2010

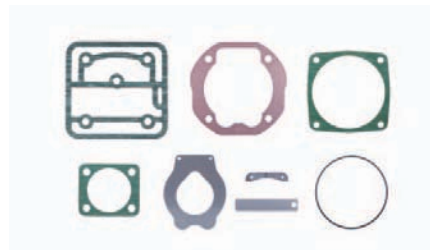

KNORR-BREMSE : I90153004 / I93078004

Repair Kit

CK.172.903

KNORR-BREMSE : STW63970 / ZB4275

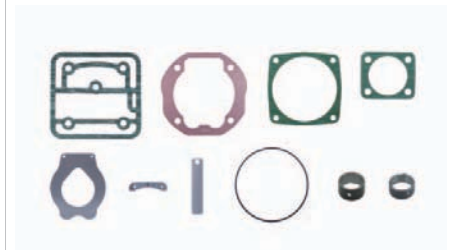
Repair Kit

CK.172.904

KNORR-BREMSE : I880570061 / I38715F004



Piston & Ring 88.00 mm CK.116.350

88.25 mm CK.116.960

88.50 mm CK.116.970

KNORR-BREMSE : SEB22555

Piston 88.00 mm CK.116.351

88.25 mm CK.116.961

88.50 mm CK.116.971

Ring 88.00 mm CW.116.352

2.00+2.00+4.00

88.25 mm CW.116.962

88.50 mm CW.116.972

Crankcase CK.149.400

Connecting Rod CK.102.500

VOLVO : 1698852
KNORR-BREMSE : B80110 / I60599

Crankshaft CK.149.601

VOLVO : 1697094
KNORR-BREMSE : I85022

Cylinder Liner & Piston CK.130.300

STD. Piston & Ring

KNORR-BREMSE : I80864/0061

Cylinder Liner CK.130.3010

VOLVO : 1697111
KNORR-BREMSE : C63059

Flange Cover CK.149.700

VOLVO : 1687207
KNORR-BREMSE : I80962

Bushing CK.102.708

34x30x16

KNORR-BREMSE : B64572

Bushing CK.102.434

34x30x16

KNORR-BREMSE : B44935

Repair Kit CK.172.905

CK.173.000

 VOLVO
 21101027

 KNORR-BREMSE
 LK4954
 K017528
 K017528N57

VEHICLE APPLICATION
 B7R

Cylinder Bore	Ø92.00	Number of Cylinders	2	Water or Air Cooled	Water	Unloader Port Size	M10x1
Stroke	54 mm	Air Inlet Port Size	M26x1,5	Through Drive	Gear	Water Inlet Port Size	M18x1,5
Swept Volume	720 cm ³	Air Delivery Port Size	M22x1,5	With ESS System	Yes	Water Delivery Port Size	M18x1,5

Complete Cylinderhead

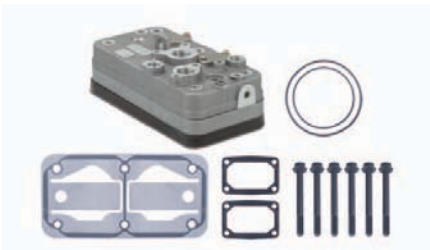
CK.173.1000

 VOLVO : 21136561
 KNORR-BREMSE : K017529

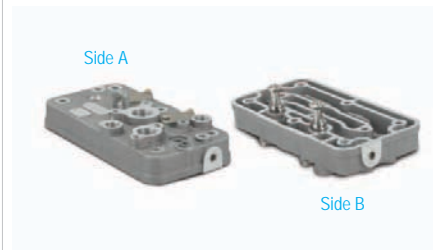
Cylinder Up Head

CK.173.1020

Cylinder Bottom Head

CK.173.1040

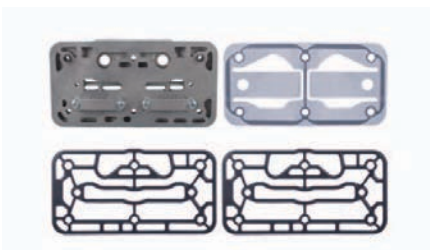

Complete Valve Plate

CK.173.200

 VOLVO : 21136726
 KNORR-BREMSE : K012074

Valve Plate

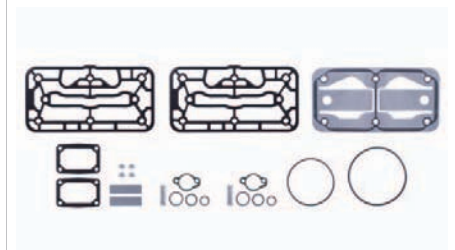
CK.173.2010

Repair Kit

CK.173.903





Piston & Ring 92.00 mm CK.173.350

2.50+2.50+4.00

92.25 mm CK.173.960

92.50 mm CK.173.970



KNORR-BREMSE : SEB22530 / K012079

Piston 92.00 mm CK.173.351

92.25 mm CK.173.961

92.50 mm CK.173.971



Ring 92.00 mm CK.165.352

2.50+2.50+4.00

92.25 mm CK.165.962

92.50 mm CK.165.972



Crankcase CK.173.400



Connecting Rod CK.173.500



Crankshaft CK.173.601



Bushing CK.116.434

42x38x25



VOLVO : 1697278 / 1697286
KNORR-BREMSE : EB00819

Rear Cover CK.173.720

Aluminum Bushing Cover



Repair Kit CK.173.901



Repair Kit CK.173.911



Repair Kit CK.173.913

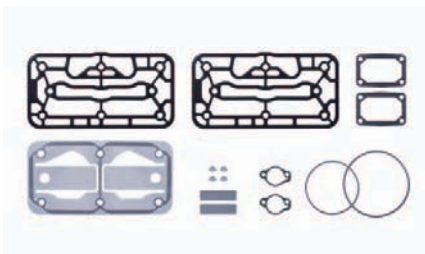

KNORR-BREMSE : K012086

Valve Kit CK.173.921



KNORR-BREMSE : K034874K50

CK.185.000

 VOLVO
 20568594
 3181133
 85000345

 KNORR-BREMSE
 LP3970

VEHICLE APPLICATION
 FL6

Cylinder Bore	Ø92.00	Number of Cylinders	1	Water or Air Cooled	Water	Unloader Port Size	-
Stroke	54 mm	Air Inlet Port Size	M26x1,5	Through Drive	Gear	Water Inlet Port Size	M16x1,5
Swept Volume	360 cm ³	Air Delivery Port Size	M18x1,5	With ESS System	-	Water Delivery Port Size	M16x1,5

Complete Cylinderhead

CK.185.100

Cylinderhead

CK.185.1010



Complete Valve Plate

CK.185.200

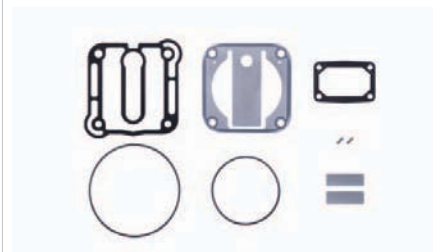

Valve Plate

CK.185.2010

Repair Kit

CK.185.903

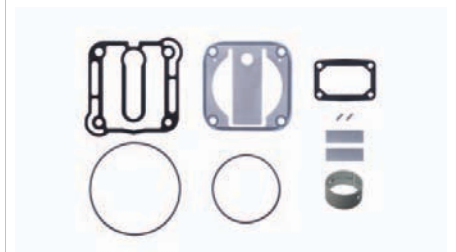
Repair Kit

CK.185.904





Piston & Ring 92.00 mm CK.173.350

2.50+2.50+4.00

92.25 mm CK.173.960

92.50 mm CK.173.970



KNORR-BREMSE : SEB22530 / K012079

Piston 92.00 mm CK.173.351

92.25 mm CK.173.961

92.50 mm CK.173.971



Ring 92.00 mm CK.165.352

2.50+2.50+4.00

92.25 mm CK.165.962

92.50 mm CK.165.972



Crankcase CK.185.400



Connecting Rod CK.108.500



VOLVO : 3090386 / 1698528 / 1697281
KNORR-BREMSE : SEB00626004 / SEB00957004

Crankshaft CK.185.601



Bushing CK.116.434

42x38x25



VOLVO : 1697278 / 1697286
KNORR-BREMSE : EB00819

Rear Cover CK.116.720

Aluminum Bushing Cover



VOLVO : 3097150
KNORR-BREMSE : II159920065

Gasket Kit CK.185.905



VOLVO : 85104328

Valve Kit CK.185.906



Repair Kit CK.185.911

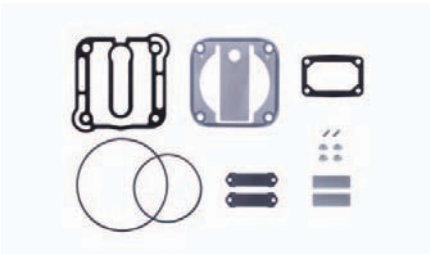

Nut MC202061FX

M20x1.5 Right Hand



VOLVO : 1698672

CK.195.000

 VOLVO
 20429337
 3987601
 8113263
 85000063

 KNORR-BREMSE
 LK3982
 K000274000

CK.205.000

 VOLVO
 1628592
 8112583

 KNORR-BREMSE
 LK3930
 II18606

VEHICLE APPLICATION
 FH12 / FH16 / F16

Cylinder Bore	Ø88.00	Number of Cylinders	1	Water or Air Cooled	Water	Unloader Port Size	M22x1,5
Stroke	50 mm	Air Inlet Port Size	Ø29	Through Drive	Gear	Water Inlet Port Size	M16x1,5
Swept Volume	300 cm ³	Air Delivery Port Size	M26x1,5	With ESS System	Yes	Water Delivery Port Size	M16x1,5

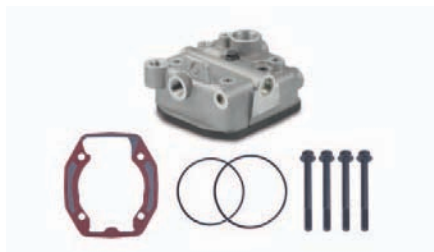
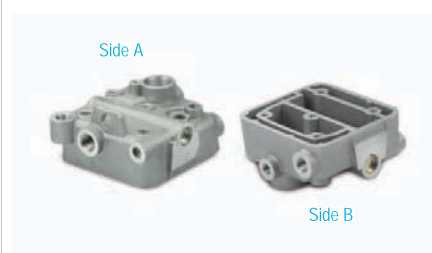
 Complete Cylinderhead **CK.195.100**

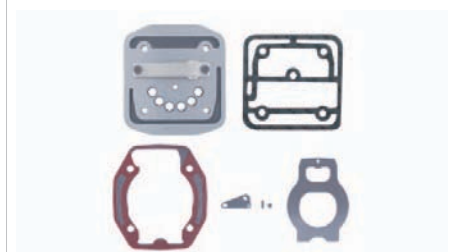
 Cylinderhead **CK.195.1010**

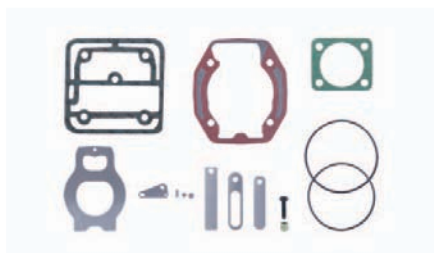
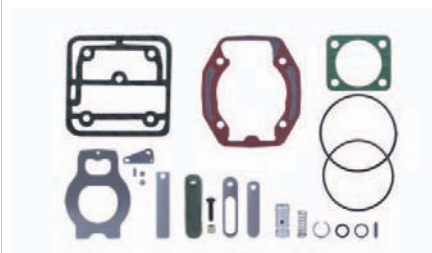
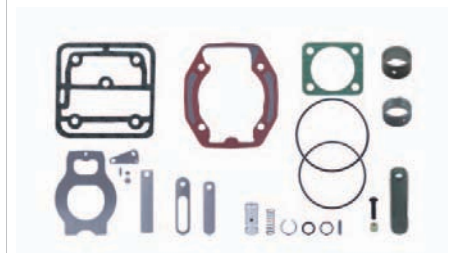
 VOLVO : 1699823
 KNORR-BREMSE : II162440061

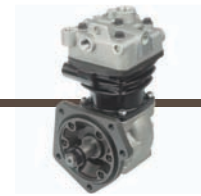
 Complete Valve Plate **CK.195.200**

 VOLVO : 1699825
 KNORR-BREMSE : II14777004

 Repair Kit **CK.195.912**

 Repair Kit **CK.195.903**

 Repair Kit **CK.195.904**



Piston & Ring 88.00 mm CK.116.350

88.25 mm CK.116.960

88.50 mm CK.116.970

KNORR-BREMSE : SEB22555

Piston 88.00 mm CK.116.351

88.25 mm CK.116.961

88.50 mm CK.116.971

Ring 88.00 mm CW.116.352

2.00+2.00+4.00

88.25 mm CW.116.962

88.50 mm CW.116.972

Crankcase CK.195.400

KNORR-BREMSE : I80411

Connecting Rod CK.102.500

VOLVO : 1698852
KNORR-BREMSE : B80110 / I60599

Crankshaft CK.195.601

KNORR-BREMSE : I85022

Cylinder Liner & Piston CK.137.300

STD. Piston & Ring

KNORR-BREMSE : I808640061

Cylinder Liner CK.137.3010

KNORR-BREMSE : K000998

Flange Cover CK.195.700

KNORR-BREMSE : I114864

Bushing CK.102.708

34x30x16

KNORR-BREMSE : B64572

Bushing CK.102.434

34x30x16

KNORR-BREMSE : B44935

Repair Kit CK.195.905

VOLVO : 1699822
KNORR-BREMSE : I1147860051

CK.203.000

 VOLVO
 20429341
 8113406
 8122459

 KNORR-BREMSE
 LK3986
 K000275000

VEHICLE APPLICATION

 FH12 / FH16
 FM12
 F16

Cylinder Bore	Ø88.00	Number of Cylinders	1	Water or Air Cooled	Water	Unloader Port Size	-
Stroke	50 mm	Air Inlet Port Size	Ø29	Through Drive	Gear	Water Inlet Port Size	M16x1,5
Swept Volume	300 cm ³	Air Delivery Port Size	M26x1,5	With ESS System	No	Water Delivery Port Size	M16x1,5

Complete Cylinderhead

CK.203.100

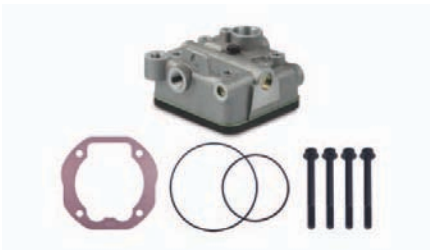

Cylinderhead

CK.203.1010

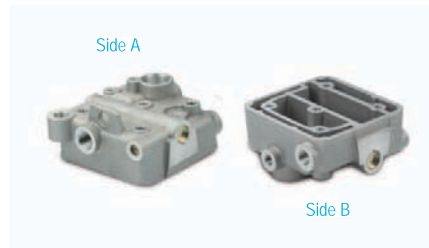

Complete Valve Plate

CK.203.200

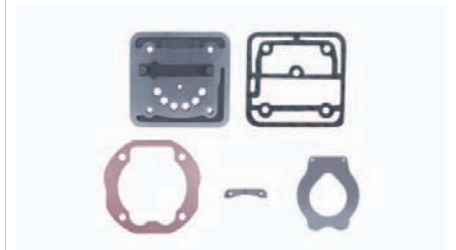

VOLVO : 3099753

Repair Kit

CK.203.910



Repair Kit

CK.203.903

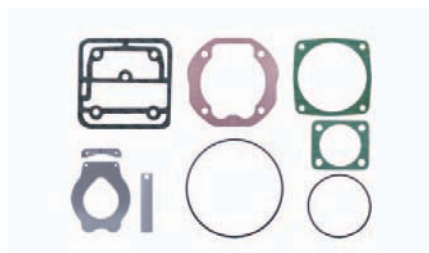

Repair Kit

CK.203.904

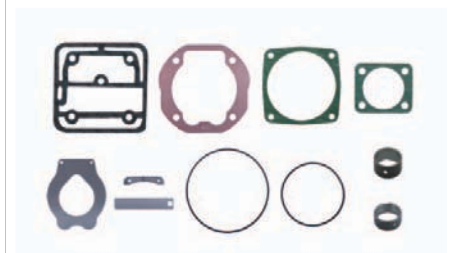

VOLVO : 3099754



Piston & Ring 88.00 mm **CK.116.350**

88.25 mm **CK.116.960**

88.50 mm **CK.116.970**

KNORR-BREMSE : SEB22555

Piston 88.00 mm **CK.116.351**

88.25 mm **CK.116.961**

88.50 mm **CK.116.971**

Ring 88.00 mm **CW.116.352**

2.00+2.00+4.00 88.25 mm **CW.116.962**

88.50 mm **CW.116.972**

Crankcase **CK.195.400**

KNORR-BREMSE : I80411

Connecting Rod **CK.102.500**

VOLVO : 1698852
KNORR-BREMSE : B80110 / I60599

Crankshaft **CK.195.601**

KNORR-BREMSE : I85022

Cylinder Liner & Piston **CK.105.300**

STD. Piston & Ring

Cylinder Liner **CK.105.3010**

Flange Cover **CK.195.700**

KNORR-BREMSE : II14864

Bushing **CK.102.708**

34x30x16

KNORR-BREMSE : B64572

Bushing **CK.102.434**

34x30x16

KNORR-BREMSE : B44935

Repair Kit **CK.203.905**

KNORR-BREMSE : II1377570051

CK.208.000

 VOLVO
 20442353
 8157550
 8112851
 85000065

 KNORR-BREMSE
 LP4960

VEHICLE APPLICATION
 FL12

Cylinder Bore	Ø88.00	Number of Cylinders	2	Water or Air Cooled	Water	Unloader Port Size	M22x1,5
Stroke	50 mm	Air Inlet Port Size	Ø29	Through Drive	Gear	Water Inlet Port Size	M16x1,5
Swept Volume	608 cm ³	Air Delivery Port Size	M26x1,5	With ESS System	Yes	Water Delivery Port Size	M16x1,5

Complete Cylinderhead

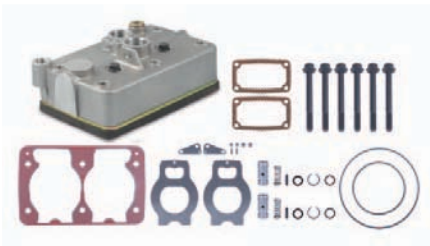
CK.116.1000

Cylinderhead

CK.116.1010

FIT LP4934 / LP4949 / LP4960 / LP4967 / LP4968

 VOLVO : 3097144
 KNORR-BREMSE : SEB01052004

Complete Valve Plate

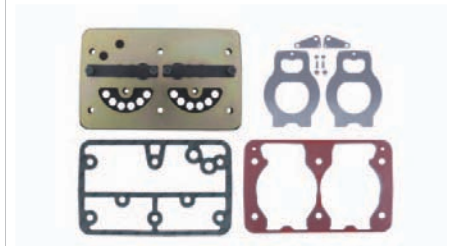
CK.116.200

 VOLVO : 3097146
 KNORR-BREMSE : SEB01033004

Valve Plate

CK.116.2010

Repair Kit

CK.116.903

Repair Kit

CK.116.905



Piston & Ring 88.00 mm CK.116.350

2.50+2.50+4.00

88.25 mm CK.116.960

88.50 mm CK.116.970

VOLVO : 85101375 / 3095841 / 1698848
 KNORR-BREMSE : SEB22555

Piston 88.00 mm CK.116.351

88.25 mm CK.116.961

88.50 mm CK.116.971

Ring 88.00 mm CK.116.352

2.50+2.50+4.00

88.25 mm CK.116.962

88.50 mm CK.116.972

VOLVO : 85100626 / 3097153
 KNORR-BREMSE : II39526F0061

Crankcase CK.117.400

Connecting Rod CK.116.500

VOLVO : 3097151
 KNORR-BREMSE : SEB00967004

Crankshaft CK.117.601

Bushing CK.116.434

42x38x25

VOLVO : 1697278 / 1697286
 KNORR-BREMSE : EB00819

Rear Cover CK.116.720

Aluminum Bushing Cover

VOLVO : 3097150
 KNORR-BREMSE : II159920065

Valve Kit CK.116.907

VOLVO : 3091739
 KNORR-BREMSE : II326840061

Valve Kit CK.116.908

VOLVO : 3091718
 KNORR-BREMSE : SEB01138004 / SEB011380061

Repair Kit CK.116.912

Repair Kit CK.116.921

VOLVO : 3097147
 KNORR-BREMSE : II159920063

CK.233.000

 VOLVO
 20568592
 85000344
 3181132
 8113829
 85000433

 KNORR-BREMSE
 LK3841

VEHICLE APPLICATION
 FL6

Cylinder Bore	Ø80.00	Number of Cylinders	1	Water or Air Cooled	Water	Unloader Port Size	-
Stroke	45 mm	Air Inlet Port Size	M26x1,5	Through Drive	Gear	Water Inlet Port Size	M16x1,5
Swept Volume	225 cm ³	Air Delivery Port Size	M18x1,5	With ESS System	-	Water Delivery Port Size	M16x1,5

Complete Cylinderhead

CK.233.100

KNORR-BREMSE : K034890K50

Cylinderhead

CK.233.1010

Complete Valve Plate

CK.233.200

KNORR-BREMSE : SEB01916004

Valve Plate

CK.233.2010

Repair Kit

CK.233.901

Repair Kit

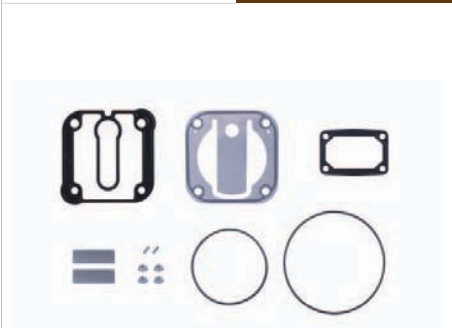
CK.233.903



Piston & Ring 80.00 mm CN.127.350

2.50+2.50+4.00

80.25 mm CN.127.960

80.50 mm CN.127.970

KNORR-BREMSE : SEB22517

Piston 80.00 mm CN.127.351

80.25 mm CN.127.961

80.50 mm CN.127.971

Ring 80.00 mm CN.127.352

2.50+2.50+4.00

80.25 mm CN.127.962

80.50 mm CN.127.972

Crankcase CK.233.400

Connecting Rod CK.107.500

VOLVO : 1697281 / 1698528 / 3090386
KNORR-BREMSE : SEB00626004 / SEB00957004

Crankshaft CK.234.601

Bushing CK.116.434

42x38x25

VOLVO : 1697278 / 1697286
KNORR-BREMSE : EB00819

Crankshaft Nut MC202061FX

M20x1.5 Right Hand Thread

VOLVO : 1698672

Rear Cover CK.116.720

Aluminum Bushing Cover

VOLVO : 3097150
KNORR-BREMSE : II159920065

Repair Kit CK.233.904

Repair Kit CK.233.911

Repair Kit CK.233.913

KNORR-BREMSE : SEB22518

CV.101.000

VOLVO
3038304
VARGA
RCCS00229
EL1600

VEHICLE APPLICATION

NL10 / NL12
N10 / N12
B10M / B58



Cylinder Bore	Ø69.85 mm	Number of Cylinders	2	Water or Air Cooled	Water	Unloader Port Size	1/8" NPT
Stroke	47.50 mm	Air Inlet Port Size	-	Through Drive	-	Water Inlet Port Size	1/2" NPT
Swept Volume	360 cm ³	Air Delivery Port Size	Ø22.50 mm	With ESS System	Yes	Water Delivery Port Size	1/2" NPT

Complete Cylinderhead

CV.101.100



VARGA : RCCG 0003.2

Repair Kit

CV.101.903

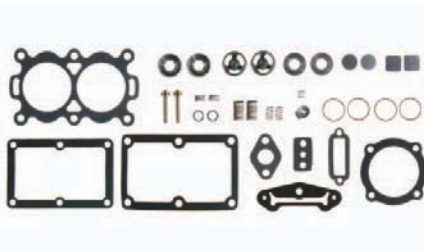

Repair Kit

CV.101.910

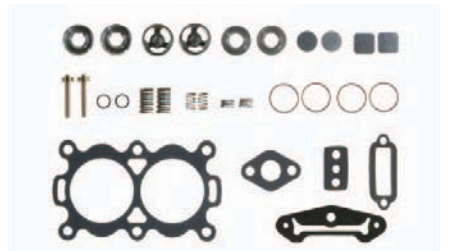

VARGA : RRCG 0010.1

Repair Kit

CV.101.906



Repair Kit

CV.101.912



Repair Kit

CV.101.915





Piston & Ring

69.85 mm CV.101.350

70.10 mm CV.101.960

70.35 mm CV.101.970

VARGA : RREB 0010.6 STD

Piston

69.85 mm CV.101.351

70.10 mm CV.101.961

70.35 mm CV.101.971

VARGA : RREB 0010.6 STD

Ring

69.85 mm CV.101.352

70.10 mm CV.101.962

70.35 mm CV.101.972

VARGA : RRAN 0001.6 STD

Crankcase

CV.101.400

VARGA : RPCY 0006.2

Connecting Rod

CV.101.500

VARGA : RPBI 0001.9

Connecting Rod Bearing

CV.101.507

VARGA : RRCQ 004.1 STD

Crankshaft

CV.101.601

VARGA : RPVI 0016.1

Cylinder Liner

CV.101.3010

VARGA : RPBL 0008.2

Ball Bearing

6207

VARGA : RPBI 0001.2

Unloader Cover

CV.101.050

VARGA : RRTP 0014.4

Rear Cover

CV.101.720

VARGA : RRTP 0014.4

Sump Cover

CV.101.751

VARGA : RRTP 0014.4

CW.107.000

VOLVO
1626060
5003460
WABCO
911 505 150 0

VEHICLE APPLICATION

F10 / F12 / F16
FL10 / FL7
NL12
FM10



Cylinder Bore	Ø85.00	Number of Cylinders	2	Water or Air Cooled	Water	Unloader Port Size	-
Stroke	62 mm	Air Inlet Port Size	Ø35	Through Drive	Gear	Water Inlet Port Size	M16x1,5
Swept Volume	704 cm ³	Air Delivery Port Size	M26x1,5	With ESS System	-	Water Delivery Port Size	M16x1,5

Complete Cylinderhead

CW.107.100

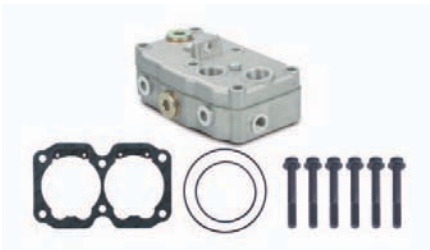

VOLVO : 3094622
WABCO : 911 505 804 2

Cylinder Up Head

CW.107.1020



Cylinder Bottom Head

CW.107.1040



Repair Kit

CW.107.903



Gasket Kit

CW.107.905

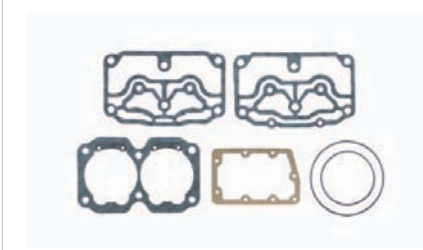

Valve Kit

CW.107.906



VOLVO : 85104629
WABCO : 911 505 001 2



Piston & Ring 85.00 mm CW.107.350

85.25 mm CW.107.960

85.50 mm CW.107.970



VOLVO : 1698686
WABCO : 911 501 624 2 / 911 501 625 2

Piston 85.00 mm CW.107.351

85.25 mm CW.107.961

85.50 mm CW.107.971



Ring 85.00 mm CW.109.352

2.00+2.00+4.00

85.25 mm CW.109.962

85.50 mm CW.109.972



VOLVO : 3094621
WABCO : 911 501 920 2

Crankcase **CW.107.400**



Connecting Rod **CW.107.500**



VOLVO : 1698678
WABCO : 911 505 732 2

Crankshaft **CW.107.601**



VOLVO : 1698670
WABCO : 911 505 691 4

Ball Bearing **6307**



VOLVO : 1698671
WABCO : 895 251 02 02

Crankshaft Nut **MC202061FX**

M20x1.5 Right Hand Thread



VOLVO : 1698672

Rear Cover **CW.107.720**



VOLVO : 3094836
WABCO : 911 505 664 4

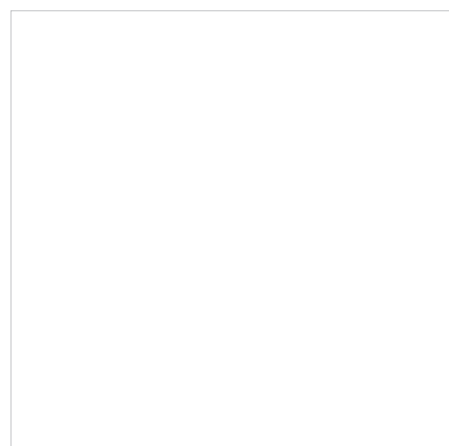
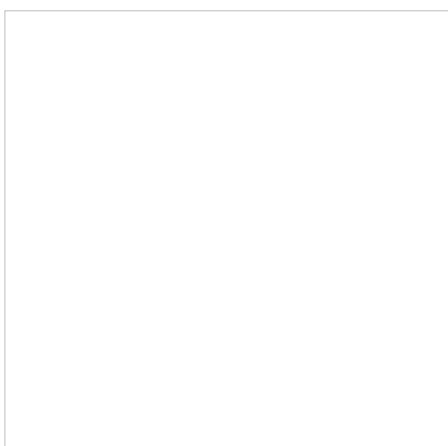
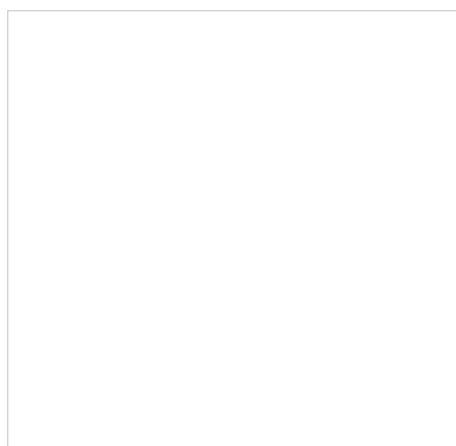

CW.118.000

 VOLVO
 20382348
 21353460

 WABCO
 412 352 005 0
 412 352 030 0

VEHICLE APPLICATION

 FH12
 FM12
 NH12

Cylinder Bore	Ø85.00	Number of Cylinders	1	Water or Air Cooled	Water	Unloader Port Size	M12x1,5
Stroke	62 mm	Air Inlet Port Size	Ø35	Through Drive	Gear	Water Inlet Port Size	M16x1,5
Swept Volume	352 cm ³	Air Delivery Port Size	M26x1,5	With ESS System	Yes	Water Delivery Port Size	M16x1,5

Complete Cylinderhead

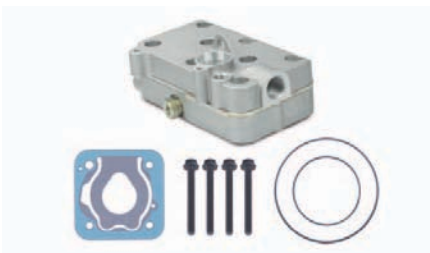
CW.118.100

 VOLVO : 85104246
 WABCO : 412 352 921 2

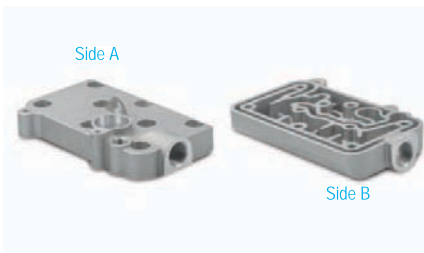
Cylinder Up head

CW.118.1020

Cooling Plate

CW.118.238

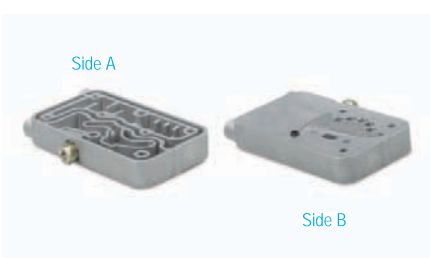

Cylinder Bottom Head

CW.118.1040

Repair Kit

CW.118.901

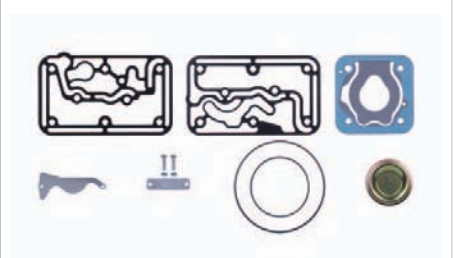
Repair Kit

CW.118.903

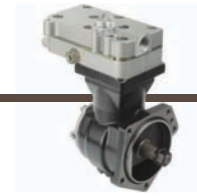

Piston & Ring 85.00 mm CW.109.350

85.25 mm CW.109.960

85.50 mm CW.109.970

VOLVO : 1698686
WABCO : 911 501 624 2 / 911 501 625 2

Piston 85.00 mm CW.109.351

85.25 mm CW.109.961

85.50 mm CW.109.971

Ring 85.00 mm CW.109.352

2.00+2.00+4.00

85.25 mm CW.109.962

85.50 mm CW.109.972

VOLVO : 3094621
WABCO : 911 501 920 2

Crankcase CW.118.400

WABCO : 412 352 012 6

Connecting Rod CW.107.500

VOLVO : 1698678
WABCO : 911 505 732 2

Crankshaft CW.118.601

WABCO : 412 352 691 4

Bushing CW.101.434

39x35x20

Crankshaft Nut MC202061FX

M20x1.5 Right Hand Thread

VOLVO : 1698672

Rear Cover CW.118.720

Aluminum Bushing Cover

Repair Kit CW.118.904

Gasket Kit CW.118.913

VOLVO : 85102273
WABCO : 412 352 003 2

Sump Cover CW.123.751

VOLVO : 3094835
WABCO : 895 073 589 4

CW.142.000

 VOLVO
 20701801
 20382347
 20547525
 85000396
 20569224

 WABCO
 412 704 008 0
 412 704 001 0
 412 704 004 0
 412 704 005 0

VEHICLE APPLICATION

 FH12
 FM12
 NH12

Cylinder Bore	Ø85.00	Number of Cylinders	2	Water or Air Cooled	Water	Unloader Port Size	M12x1
Stroke	62 mm	Air Inlet Port Size	Ø35	Through Drive	Gear	Water Inlet Port Size	M16x1,5
Swept Volume	704 cm ³	Air Delivery Port Size	M26x1,5	With ESS System	Yes	Water Delivery Port Size	M16x1,5

Complete Cylinderhead

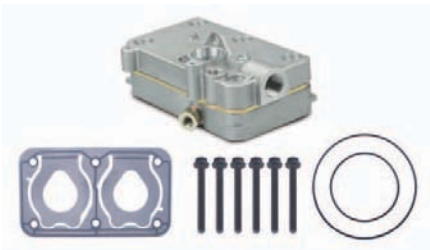
CW.142.100

 VOLVO : 20701803
 WABCO : 412 704 932 2

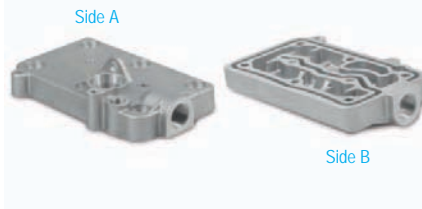
Cylinder Up head

CW.142.1020

Cooling Plate

CW.142.238

Cylinder Bottom Head

CW.142.1040

Repair Kit

CW.142.901

Repair Kit

CW.142.903



Piston & Ring 85.00 mm CW.109.350

85.25 mm CW.109.960

85.50 mm CW.109.970

VOLVO : 1698686
WABCO : 911 501 624 2 / 911 501 625 2

Piston 85.00 mm CW.109.351

85.25 mm CW.109.961

85.50 mm CW.109.971

VOLVO : 1698686
WABCO : 911 501 624 2 / 911 501 625 2

Ring 85.00 mm CW.109.352

2.00+2.00+4.00

85.25 mm CW.109.962

85.50 mm CW.109.972

VOLVO : 3094621
WABCO : 911 501 920 2

Crankcase CW.142.400

VOLVO : 1698678
WABCO : 911 505 732 2

Connecting Rod CW.107.500

VOLVO : 1698678
WABCO : 911 505 732 2

Crankshaft CW.142.601

VOLVO : 1698678
WABCO : 911 505 732 2

Bushing CW.142.434

VOLVO : 1698672
WABCO : 411 522 340 4

Crankshaft Nut MC202061FX

M20x1.5 Right Hand Thread

VOLVO : 1698672

Rear Cover CW.142.720

Aluminum Bushing Cover

VOLVO : 1698672

Repair Kit CW.142.904

VOLVO : 3094835
WABCO : 895 073 589 4

Repair Kit CW.142.913

VOLVO : 3094835
WABCO : 895 073 589 4

Sump Cover CW.123.751

VOLVO : 3094835
WABCO : 895 073 589 4

CW.158.000

 VOLVO
 20382346
 20478166
 21353457

 WABCO
 412 352 004 0
 412 352 029 0

VEHICLE APPLICATION

 FH12
 FM9
 FM12
 NH12

Cylinder Bore	Ø85.00	Number of Cylinders	1	Water or Air Cooled	Water	Unloader Port Size	M12x1,5
Stroke	62 mm	Air Inlet Port Size	Ø35	Through Drive	Gear	Water Inlet Port Size	M16x1,5
Swept Volume	352 cm ³	Air Delivery Port Size	M26x1,5	With ESS System	Yes	Water Delivery Port Size	M16x1,5

Complete Cylinderhead

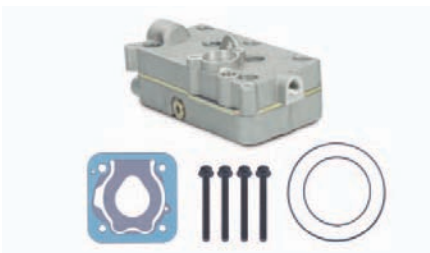
CW.208.100

 VOLVO : 85104248
 WABCO : 412 352 920 2

Cylinder Up head

CW.208.1020

Cooling Plate

CW.208.238



Cylinder Bottom Head

CW.208.1040

Repair Kit

CW.208.901

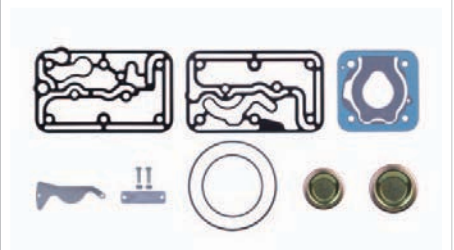
Repair Kit

CW.208.903

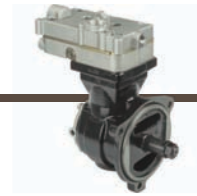

Piston & Ring 85.00 mm CW.109.350

85.25 mm CW.109.960

85.50 mm CW.109.970

VOLVO : 1698686
WABCO : 911 501 624 2 / 911 501 625 2

Piston 85.00 mm CW.109.351

85.25 mm CW.109.961

85.50 mm CW.109.971

Ring 85.00 mm CW.109.352

2.00+2.00+4.00

85.25 mm CW.109.962

85.50 mm CW.109.972

VOLVO : 3094621
WABCO : 911 501 920 2

Crankcase CW.158.400

Connecting Rod CW.107.500

VOLVO : 1698678
WABCO : 911 505 732 2

Crankshaft CW.158.601

Bushing CW.101.434

39x35x20

Crankshaft Nut MC202061FX

M20x1.5 Right Hand Thread

VOLVO : 1698672

Rear Cover CW.118.720

Aluminum Bushing Cover

Repair Kit CW.208.904

Gasket Kit CW.208.913

VOLVO : 85103938
WABCO : 412 352 004 2

Sump Cover CW.123.751

VOLVO : 3094835
WABCO : 895 073 589 4

CW.184.000

VOLVO
 20775224
 85000491
 WABCO
 412 704 013 0

VEHICLE APPLICATION

B9R
 B9L
 B9S
 B9TL



Cylinder Bore	Ø85.00	Number of Cylinders	2	Water or Air Cooled	Water	Unloader Port Size	M12x1,5
Stroke	62 mm	Air Inlet Port Size	Ø35	Through Drive	Gear	Water Inlet Port Size	M16x1,5
Swept Volume	704 cm ³	Air Delivery Port Size	M26x1,5	With ESS System	Yes	Water Delivery Port Size	M16x1,5

Complete Cylinderhead

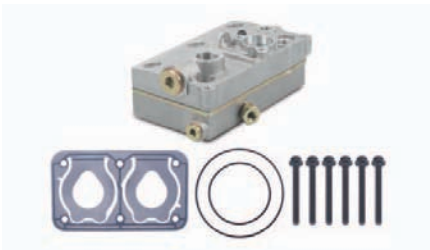
CW.184.100

VOLVO : 20775236
 WABCO : 412 704 934 2

Cylinder Up head

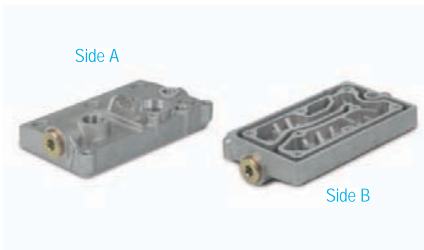
CW.184.1020

Cooling Plate

CW.184.238

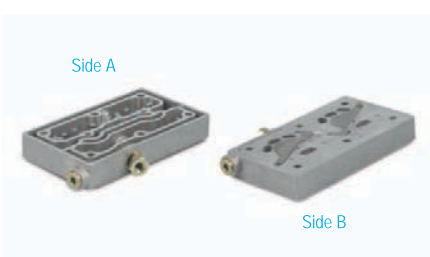

Cylinder Bottom Head

CW.184.1040

Repair Kit

CW.184.901

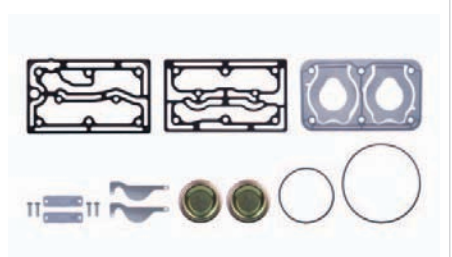
Repair Kit

CW.184.903



Piston & Ring 85.00 mm CW.109.350

85.25 mm CW.109.960

85.50 mm CW.109.970



VOLVO : 1698686
WABCO : 911 501 624 2 / 911 501 625 2

Piston 85.00 mm CW.109.351

85.25 mm CW.109.961

85.50 mm CW.109.971



Ring 85.00 mm CW.109.352

2.00+2.00+4.00

85.25 mm CW.109.962

85.50 mm CW.109.972



VOLVO : 3094621
WABCO : 911 501 920 2

Crankcase **CW.184.400**



Connecting Rod **CW.107.500**



VOLVO : 1698678
WABCO : 911 505 732 2

Crankshaft **CW.189.601**



WABCO : 412 704 691 4

Bushing **CW.142.434**



WABCO : 411 522 340 4

Crankshaft Nut **MC202061FX**

M20x1.5 Right Hand Thread



VOLVO : 1698672

Rear Cover **CW.142.720**

Aluminum Bushing Cover



Repair Kit **CW.184.904**



Repair Kit **CW.184.913**



WABCO : 412 704 939 2

Sump Cover **CW.123.751**



VOLVO : 3094835
WABCO : 895 073 589 4

CW.189.000

 VOLVO
 20845313
 20850846
 20765890

 WABCO
 412 704 015 0
 412 704 012 0

VEHICLE APPLICATION

 FH12 / FH16 / FH13
 FM12 / FM9
 NH12

Cylinder Bore	Ø85.00	Number of Cylinders	2	Water or Air Cooled	Water	Unloader Port Size	M16x1,5
Stroke	62 mm	Air Inlet Port Size	Ø35	Through Drive	Gear	Water Inlet Port Size	M16x1,5
Swept Volume	704 cm ³	Air Delivery Port Size	M26x1,5	With ESS System	Yes	Water Delivery Port Size	M16x1,5

Complete Cylinderhead

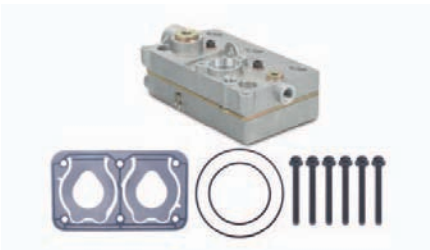
CW.189.100

 VOLVO : 20845004
 WABCO : 412 704 933 2

Cylinder Up head

CW.189.1020

Cooling Plate

CW.189.238

Cylinder Bottom Head

CW.189.1040

Repair Kit

CW.189.901

Repair Kit

CW.189.903



Piston & Ring 85.00 mm CW.109.350

85.25 mm CW.109.960

85.50 mm CW.109.970

VOLVO : 1698686
WABCO : 911 501 624 2 / 911 501 625 2

Piston 85.00 mm CW.109.351

85.25 mm CW.109.961

85.50 mm CW.109.971

Ring 85.00 mm CW.109.352

2.00+2.00+4.00

85.25 mm CW.109.962

85.50 mm CW.109.972

VOLVO : 3094621
WABCO : 911 501 920 2

Crankcase CW.189.400

Connecting Rod CW.107.500

VOLVO : 1698678
WABCO : 911 505 732 2

Crankshaft CW.189.601

WABCO : 412 704 691 4

Bushing CW.142.434

WABCO : 411 522 340 4

Crankshaft Nut MC202061FX

M20x1.5 Right Hand Thread

VOLVO : 1698672

Rear Cover CW.142.720

Aluminum Bushing Cover

Repair Kit CW.189.904

Repair Kit CW.189.913

WABCO : 412 704 939 2

Sump Cover CW.123.751

VOLVO : 3094835
WABCO : 895 073 589 4

CW.190.000

VOLVO
20774294
WABCO
912 512 004 0

CW.201.000

VOLVO
20846000
22016995
WABCO
912 512 008 0
912 512 029 0

VEHICLE APPLICATION

FH12 / FH13 / FH16
FM9 / FM12 / FM13
B13R



Cylinder Bore	Ø85.00	Number of Cylinders	2	Water or Air Cooled	Water	Unloader Port Size	M16x1,5
Stroke	56 mm	Air Inlet Port Size	Ø35	Through Drive	Gear	Water Inlet Port Size	M16x1,5
Swept Volume	636 cm ³	Air Delivery Port Size	M26x1,5	With ESS System	Yes	Water Delivery Port Size	M16x1,5

Complete Cylinderhead

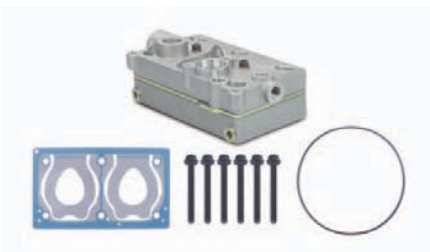
CW.190.100

VOLVO : 20775236
WABCO : 412 704 934 2

Cylinder Up head

CW.190.1020

Cooling Plate

CW.190.238

Cylinder Bottom Head

CW.190.1040

Repair Kit

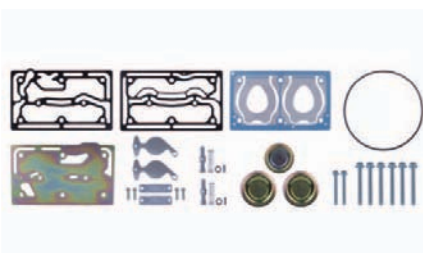
CW.190.901

Repair Kit

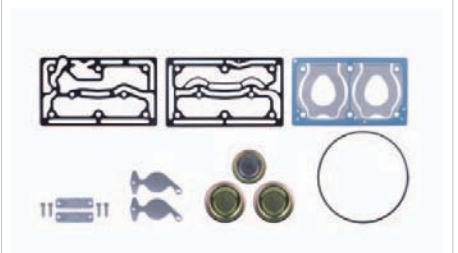
CW.190.903



Piston & Ring 85.00 mm CW.109.350

85.25 mm CW.109.960

85.50 mm CW.109.970



VOLVO : 1698686
WABCO : 911 501 624 2 / 911 501 625 2

Piston 85.00 mm CW.109.351

85.25 mm CW.109.961

85.50 mm CW.109.971



VOLVO : 1698686
WABCO : 911 501 624 2 / 911 501 625 2

Ring 85.00 mm CW.109.352

2.00+2.00+4.00

85.25 mm CW.109.962

85.50 mm CW.109.972



VOLVO : 3094621
WABCO : 911 501 920 2

Crankcase CW.193.400



VOLVO : 1698686
WABCO : 911 501 624 2 / 911 501 625 2

Connecting Rod CW.109.500



VOLVO : 1698686
WABCO : 911 501 624 2 / 911 501 625 2

Crankshaft CW.193.601



VOLVO : 1698686
WABCO : 911 501 624 2 / 911 501 625 2

Bushing CW.109.727

52x48x19



VOLVO : 1698686
WABCO : 911 501 624 2 / 911 501 625 2

Crankshaft Nut MC202061FX

M20x1.5 Right Hand Thread



VOLVO : 1698686
WABCO : 911 501 624 2 / 911 501 625 2

Rear Cover CW.193.619



VOLVO : 1698686
WABCO : 911 501 624 2 / 911 501 625 2

Repair Kit CW.190.912



VOLVO : 21322318 / 21477052
WABCO : 912 512 927 2 / 412 704 938 2

Repair Kit CW.190.913



VOLVO : 21322318 / 21477052
WABCO : 912 512 928 2

Sump Cover CW.123.751



VOLVO : 3094835
WABCO : 895 073 589 4

CW.199.000

VOLVO
 20866605
 20574763
 WABCO
 412 704 016 0

VEHICLE APPLICATION

B9R
 B9L
 B9S
 B9TL



Cylinder Bore	Ø85.00	Number of Cylinders	2	Water or Air Cooled	Water	Unloader Port Size	M12x1,5
Stroke	62 mm	Air Inlet Port Size	Ø35	Through Drive	Gear	Water Inlet Port Size	M16x1,5
Swept Volume	704 cm ³	Air Delivery Port Size	M26x1,5	With ESS System	Yes	Water Delivery Port Size	M16x1,5

Complete Cylinderhead

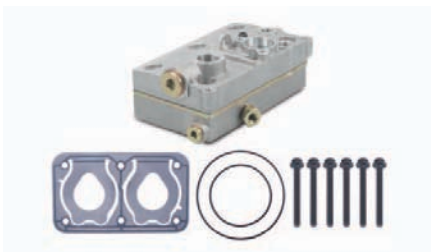
CW.184.100

VOLVO : 20775236
 WABCO : 412 704 934 2

Cylinder Up head

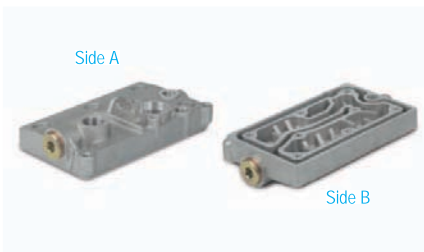
CW.184.1020

Cooling Plate

CW.184.238

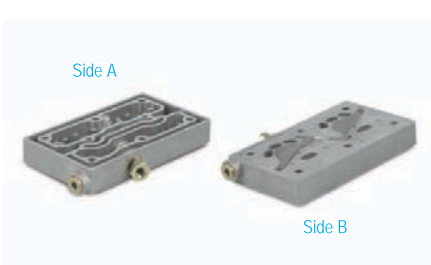

Cylinder Bottom Head

CW.184.1040

Repair Kit

CW.184.901

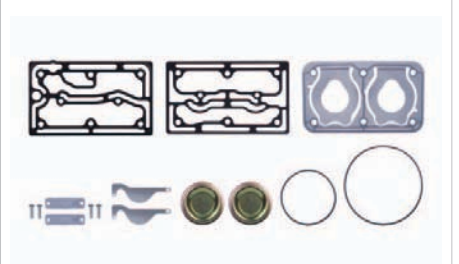
Repair Kit

CW.184.903



Piston & Ring 85.00 mm CW.109.350

85.25 mm CW.109.960

85.50 mm CW.109.970



VOLVO : 1698686
WABCO : 911 501 624 2 / 911 501 625 2

Piston 85.00 mm CW.109.351

85.25 mm CW.109.961

85.50 mm CW.109.971



Ring 85.00 mm CW.109.352

2.00+2.00+4.00

85.25 mm CW.109.962

85.50 mm CW.109.972



VOLVO : 3094621
WABCO : 911 501 920 2

Crankcase CW.184.400



Connecting Rod CW.107.500



VOLVO : 1698678
WABCO : 911 505 732 2

Crankshaft CW.189.601



WABCO : 412 704 691 4 / 412 704 941 2

Bushing CW.142.434



WABCO : 411 522 340 4

Crankshaft Nut MC202061FX

M20x1.5 Right Hand Thread



VOLVO : 1698672

Rear Cover CW.142.720

Aluminum Bushing Cover



Repair Kit CW.184.904



Repair Kit CW.184.913



WABCO : 412 704 939 2

Sump Cover CW.123.751

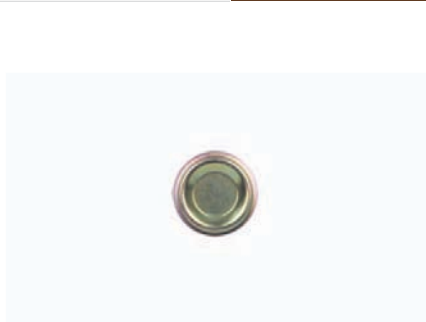

VOLVO : 3094835
WABCO : 895 073 589 4

CW.200.000

 VOLVO
 21172036
 85003282
 21379906
 22040497

 WABCO
 412 704 018 0
 412 704 023 0
 412 704 027 0

VEHICLE APPLICATION

 FH12 / FH13 / FH16
 FM9 / FM12 / FM13
 B13R

Cylinder Bore	Ø85.00	Number of Cylinders	2	Water or Air Cooled	Water	Unloader Port Size	M16x1,5
Stroke	62 mm	Air Inlet Port Size	Ø35	Through Drive	Gear	Water Inlet Port Size	M16x1,5
Swept Volume	704 cm ³	Air Delivery Port Size	M26x1,5	With ESS System	Yes	Water Delivery Port Size	M16x1,5

Complete Cylinderhead

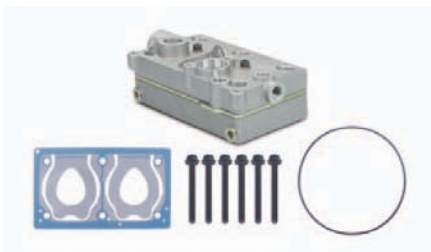
CW.190.100

 VOLVO : 20775236
 WABCO : 412 704 934 2

Cylinder Up head

CW.190.1020



Cooling Plate

CW.190.238

Cylinder Bottom Head

CW.190.1040

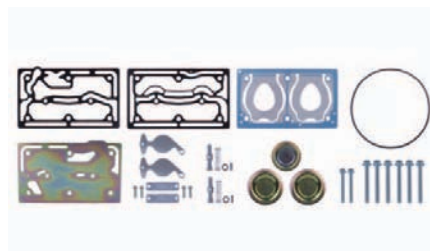
Repair Kit

CW.190.901

Repair Kit

CW.190.903



Piston & Ring 85.00 mm CW.109.350

85.25 mm CW.109.960

85.50 mm CW.109.970



VOLVO : 1698686
WABCO : 911 501 624 2 / 911 501 625 2

Piston 85.00 mm CW.109.351

85.25 mm CW.109.961

85.50 mm CW.109.971



Ring 85.00 mm CW.109.352

2.00+2.00+4.00

85.25 mm CW.109.962

85.50 mm CW.109.972



VOLVO : 3094621
WABCO : 911 501 920 2

Crankcase **CW.200.400**



Connecting Rod **CW.123.500**



WABCO : 911 145 738 2

Crankshaft **CW.200.601**



Bushing **CW.109.727**

52x48x19



Crankshaft Nut **MC202061FX**

M20x1.5 Right Hand Thread



VOLVO : 1698672

Rear Cover **CW.193.619**



WABCO : 912 000 340 4

Repair Kit **CW.190.912**



VOLVO : 21322318 / 21477052
WABCO : 912 512 927 2 / 412 704 938 2

Repair Kit **CW.190.913**



WABCO : 912 512 928 2

Sump Cover **CW.123.751**



VOLVO : 3094835
WABCO : 895 073 589 4

CW.202.000

VOLVO
 20842990
 20382345
 20478151
 20569928
 20773343
 85000614
 85000360
 85000487

WABCO
 412 704 014 0
 412 704 000 0
 412 704 006 0
 412 704 010 0

VEHICLE APPLICATION

FH12 / FH16 / FH13
 FM12 / FM9
 NH12



Cylinder Bore	Ø85.00	Number of Cylinders	2	Water or Air Cooled	Water	Unloader Port Size	M16x1,5
Stroke	62 mm	Air Inlet Port Size	Ø35	Through Drive	Gear	Water Inlet Port Size	M16x1,5
Swept Volume	704 cm ³	Air Delivery Port Size	M26x1,5	With ESS System	Yes	Water Delivery Port Size	M16x1,5

Complete Cylinderhead

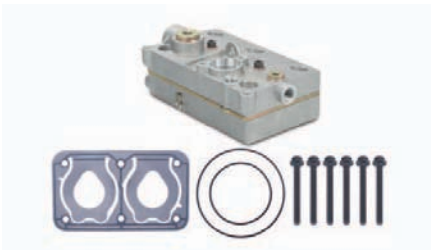
CW.202.100

VOLVO : 20845004
 WABCO : 412 704 933 2

Cylinder Up head

CW.189.1020

Cooling Plate

CW.189.238

Cylinder Bottom Head

CW.189.1040

Repair Kit

CW.202.901

Repair Kit

CW.202.903

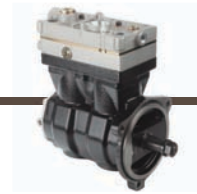
Piston & Ring 85.00 mm CW.109.350

85.25 mm CW.109.960

85.50 mm CW.109.970

VOLVO : 1698686
WABCO : 911 501 624 2 / 911 501 625 2

Piston 85.00 mm CW.109.351

85.25 mm CW.109.961

85.50 mm CW.109.971

Ring 85.00 mm CW.109.352

2.00+2.00+4.00

85.25 mm CW.109.962

85.50 mm CW.109.972

VOLVO : 3094621
WABCO : 911 501 920 2

Crankcase CW.202.400

Connecting Rod CW.107.500

VOLVO : 1698678
WABCO : 911 505 732 2

Crankshaft CW.189.601

WABCO : 412 704 691 4

Bushing CW.142.434

WABCO : 411 522 340 4

Crankshaft Nut MC202061FX

M20x1.5 Right Hand Thread

VOLVO : 1698672

Rear Cover CW.142.720

Aluminum Bushing Cover

Repair Kit CW.202.904

Repair Kit CW.202.913

WABCO : 412 704 939 2

Sump Cover CW.123.751

VOLVO : 3094835
WABCO : 895 073 589 4

CW.208.000

 VOLVO
 21353433
 20451727
 20733972

 WABCO
 912 112 000 0
 912 112 001 0
 912 114 000 0

VEHICLE APPLICATION

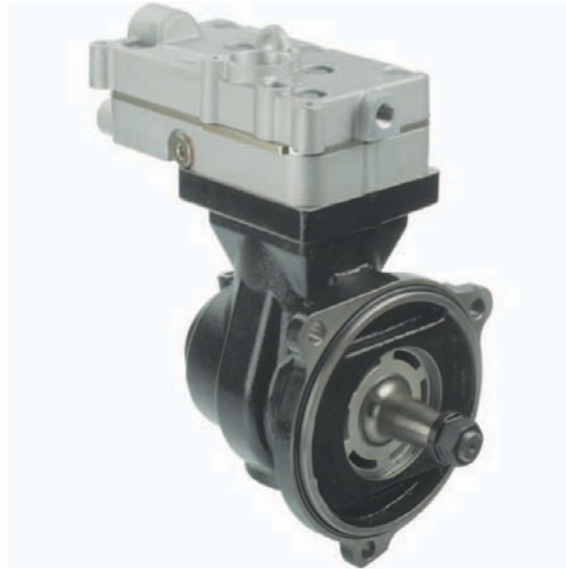
 FH12
 FM9
 FM12
 NH12

Cylinder Bore	Ø85.00	Number of Cylinders	1	Water or Air Cooled	Water	Unloader Port Size	M12x1,5
Stroke	62 mm	Air Inlet Port Size	Ø35	Through Drive	Gear	Water Inlet Port Size	M16x1,5
Swept Volume	352 cm ³	Air Delivery Port Size	M26x1,5	With ESS System	Yes	Water Delivery Port Size	M16x1,5

Complete Cylinderhead

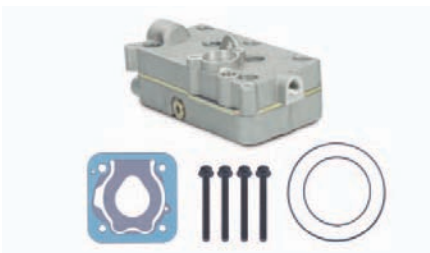
CW.208.100

 VOLVO : 85104248
 WABCO : 412 352 920 2

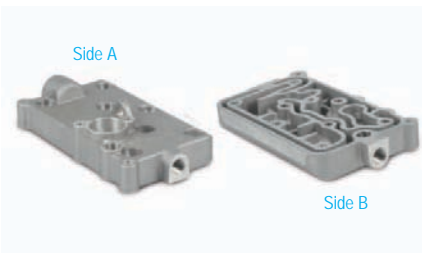
Cylinder Up head

CW.208.1020

Cooling Plate

CW.208.238

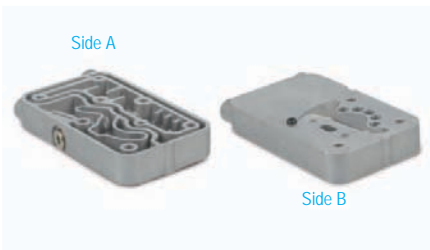

Cylinder Bottom Head

CW.208.1040

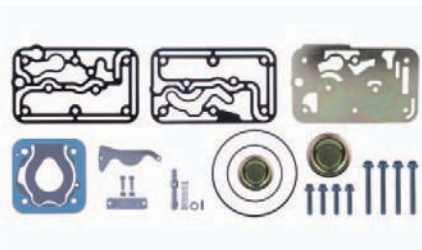
Repair Kit

CW.208.901

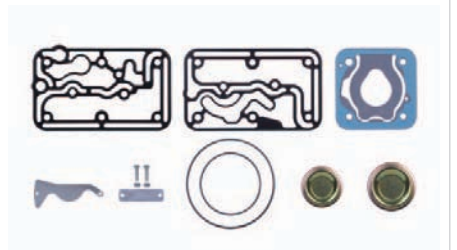
Repair Kit

CW.208.903

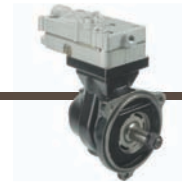

Piston & Ring 85.00 mm CW.109.350

85.25 mm CW.109.960

85.50 mm CW.109.970

VOLVO : 1698686
WABCO : 911 501 624 2 / 911 501 625 2

Piston 85.00 mm CW.109.351

85.25 mm CW.109.961

85.50 mm CW.109.971

Ring 85.00 mm CW.109.352

2.00+2.00+4.00

85.25 mm CW.109.962

85.50 mm CW.109.972

VOLVO : 3094621
WABCO : 911 501 920 2

Crankcase CW.208.400

Connecting Rod CW.123.500

WABCO : 911 145 737 2

Crankshaft CW.208.601

Bushing CW.193.708

Crankshaft Nut MC202061FX

M20x1.5 Right Hand Thread

VOLVO : 1698672

Bushing CW.109.727

52x48x19

Repair Kit CW.208.904

Gasket Kit CW.208.913

VOLVO : 85103938
WABCO : 412 352 004 2

Rear Cover CW.153.721

CW.223.000

 VOLVO
 20733974

 WABCO
 912 142 000 0

VEHICLE APPLICATION

 FH12
 FM9
 FM12
 NH12

Cylinder Bore	Ø85.00	Number of Cylinders	1	Water or Air Cooled	Water	Unloader Port Size	M12x1,5
Stroke	62 mm	Air Inlet Port Size	Ø35	Through Drive	Gear	Water Inlet Port Size	M16x1,5
Swept Volume	352 cm ³	Air Delivery Port Size	M26x1,5	With ESS System	Yes	Water Delivery Port Size	M16x1,5

Complete Cylinderhead

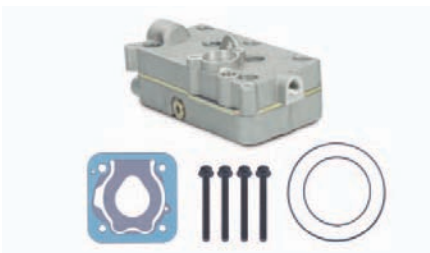
CW.208.100

 VOLVO : 85104248
 WABCO : 412 352 920 2

Cylinder Up head

CW.208.1020

Cooling Plate

CW.208.238



Cylinder Bottom Head

CW.208.1040

Repair Kit

CW.208.901

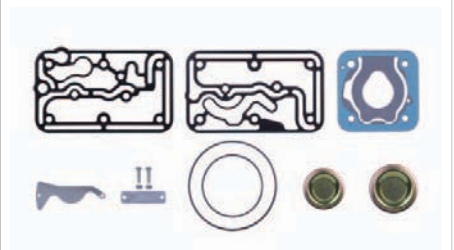
Repair Kit

CW.208.903

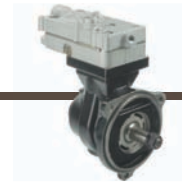

Piston & Ring 85.00 mm CW.109.350

85.25 mm CW.109.960

85.50 mm CW.109.970

VOLVO : 1698686
WABCO : 911 501 624 2 / 911 501 625 2

Piston 85.00 mm CW.109.351

85.25 mm CW.109.961

85.50 mm CW.109.971

Ring 85.00 mm CW.109.352

2.00+2.00+4.00

85.25 mm CW.109.962

85.50 mm CW.109.972

VOLVO : 3094621
WABCO : 911 501 920 2

Crankcase **CW.208.400**

Connecting Rod **CW.123.500**

WABCO : 911 145 737 2

Crankshaft **CW.208.601**

Bushing **CW.193.708**

Crankshaft Nut **MC202061FX**

M20x1.5 Right Hand Thread

VOLVO : 1698672

Bushing **CW.109.727**

52x48x19

Repair Kit **CW.208.904**

Gasket Kit **CW.208.913**

VOLVO : 85103938
WABCO : 412 352 004 2

Rear Cover **CW.153.721**

CW.244.000

 VOLVO
 20770303
 85000648

 WABCO
 912 512 006 0

VEHICLE APPLICATION
 B12B

Cylinder Bore	Ø85.00	Number of Cylinders	2	Water or Air Cooled	Water	Unloader Port Size	M16x1,5
Stroke	56 mm	Air Inlet Port Size	Ø35	Through Drive	Gear	Water Inlet Port Size	M16x1,5
Swept Volume	636 cm ³	Air Delivery Port Size	M26x1,5	With ESS System	Yes	Water Delivery Port Size	M16x1,5

Complete Cylinderhead

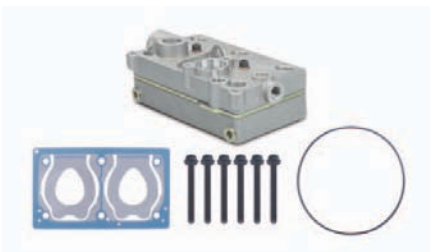
CW.244.100

 VOLVO : 20775236
 WABCO : 412 704 934 2

Cylinder Up head

CW.190.1020



Cooling Plate

CW.190.238

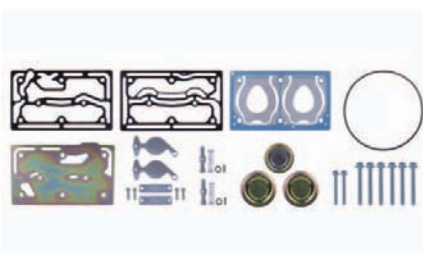

Cylinder Bottom Head

CW.190.1040

Repair Kit

CW.244.901

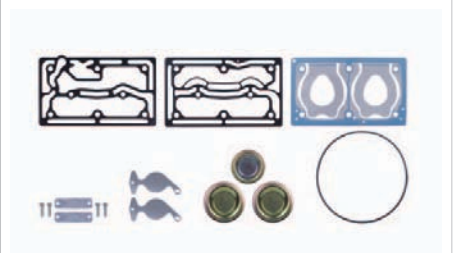
Repair Kit

CW.244.903

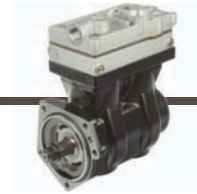

Piston & Ring 85.00 mm CW.109.350

85.25 mm CW.109.960

85.50 mm CW.109.970



VOLVO : 1698686
WABCO : 911 501 624 2 / 911 501 625 2

Piston 85.00 mm CW.109.351

85.25 mm CW.109.961

85.50 mm CW.109.971



Ring 85.00 mm CW.109.352

2.00+2.00+4.00

85.25 mm CW.109.962

85.50 mm CW.109.972



VOLVO : 3094621
WABCO : 911 501 920 2

Crankcase **CW.244.400**



Connecting Rod **CW.109.500**



WABCO : 911 145 737 2

Crankshaft **CW.244.601**



Bushing **CW.109.727**

52x48x19



Crankshaft Nut **MC202061FX**

M20x1.5 Right Hand Thread



VOLVO : 1698672

Rear Cover **CW.193.619**



WABCO : 912 000 340 4

Repair Kit **CW.244.912**



VOLVO : 21322318 / 21477052
WABCO : 912 512 927 2 / 412 704 938 2

Repair Kit **CW.244.913**



WABCO : 912 512 928 2

Sump Cover **CW.123.751**



VOLVO : 3094835
WABCO : 895 073 589 4

CW.280.000

VOLVO
 21225199
 85003351
 WABCO
 412 704 019 0

VEHICLE APPLICATION

B9R
 B9L
 B9S
 B9TL



Cylinder Bore	Ø85.00	Number of Cylinders	2	Water or Air Cooled	Water	Unloader Port Size	M12x1,5
Stroke	56 mm	Air Inlet Port Size	Ø35	Through Drive	Gear	Water Inlet Port Size	M16x1,5
Swept Volume	636 cm ³	Air Delivery Port Size	M26x1,5	With ESS System	Yes	Water Delivery Port Size	M16x1,5

Complete Cylinderhead

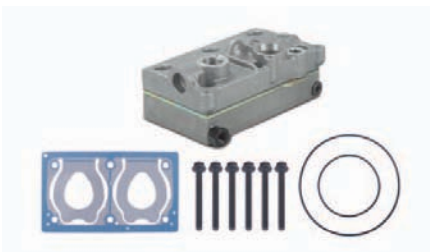
CW.280.100

VOLVO : 21316442
 WABCO : 412 704 937 2

Cylinder Up head

CW.280.1020



Cooling Plate

CW.280.238

Cylinder Bottom Head

CW.280.1040

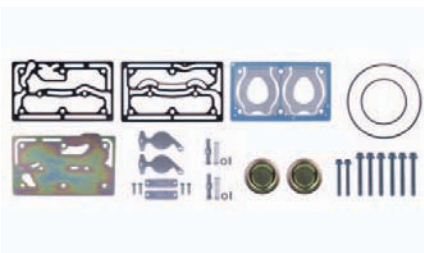
Repair Kit

CW.280.901

Repair Kit

CW.280.903



Piston & Ring 85.00 mm CW.109.350

85.25 mm CW.109.960

85.50 mm CW.109.970



VOLVO : 1698686
WABCO : 911 501 624 2 / 911 501 625 2

Piston 85.00 mm CW.109.351

85.25 mm CW.109.961

85.50 mm CW.109.971



Ring 85.00 mm CW.109.352

2.00+2.00+4.00

85.25 mm CW.109.962

85.50 mm CW.109.972



VOLVO : 3094621
WABCO : 911 501 920 2

Crankcase CW.280.400



Connecting Rod CW.107.500



VOLVO : 1698678
WABCO : 911 505 732 2

Crankshaft CW.280.601



WABCO : 412 704 941 2

Bushing CW.142.434



WABCO : 411 522 340 4

Crankshaft Nut MC202061FX

M20x1.5 Right Hand Thread



VOLVO : 1698672

Rear Cover CW.142.720

Aluminum Bushing Cover



Repair Kit CW.280.904



Repair Kit CW.280.913



VOLVO : 21322318 / 21477052
WABCO : 912 512 927 2 / 412 704 938 2

Sump Cover CW.123.751



VOLVO : 3094835
WABCO : 895 073 589 4

CW.292.000

 VOLVO
 20824559

 WABCO
 912 512 007 0

VEHICLE APPLICATION

 B12B
 B12M

Cylinder Bore	Ø85.00	Number of Cylinders	2	Water or Air Cooled	Water	Unloader Port Size	M16x1,5
Stroke	56 mm	Air Inlet Port Size	Ø35	Through Drive	Gear	Water Inlet Port Size	M16x1,5
Swept Volume	636 cm ³	Air Delivery Port Size	M26x1,5	With ESS System	Yes	Water Delivery Port Size	M16x1,5

Complete Cylinderhead

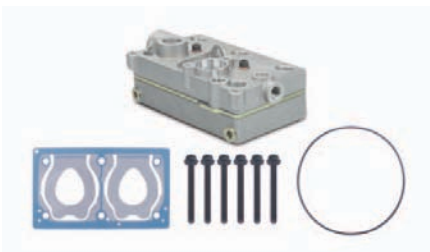
CW.244.100

 VOLVO : 20775236
 WABCO : 412 704 934 2

Cylinder Up head

CW.190.1020



Cooling Plate

CW.190.238

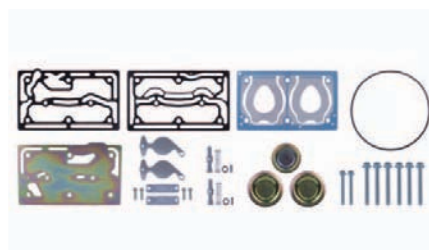

Cylinder Bottom Head

CW.190.1040

Repair Kit

CW.244.901

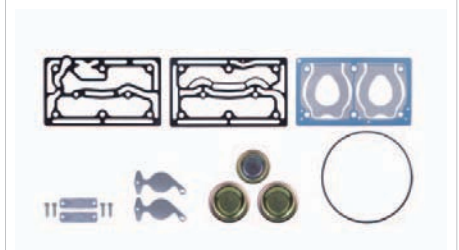
Repair Kit

CW.244.903



Piston & Ring 85.00 mm CW.109.350

85.25 mm CW.109.960

85.50 mm CW.109.970



VOLVO : 1698686
WABCO : 911 501 624 2 / 911 501 625 2

Piston 85.00 mm CW.109.351

85.25 mm CW.109.961

85.50 mm CW.109.971



Ring 85.00 mm CW.109.352

2.00+2.00+4.00

85.25 mm CW.109.962

85.50 mm CW.109.972



VOLVO : 3094621
WABCO : 911 501 920 2

Crankcase CW.292.400



Connecting Rod CW.109.500



WABCO : 911 145 737 2

Crankshaft CW.244.601



Bushing CW.109.727

52x48x19



Crankshaft Nut MC202061FX

M20x1.5 Right Hand Thread



VOLVO : 1698672

Rear Cover CW.193.619



WABCO : 912 000 340 4

Repair Kit CW.244.912



VOLVO : 21322318 / 21477052
WABCO : 912 512 927 2 / 412 704 938 2

Repair Kit CW.244.913



WABCO : 912 512 928 2

Sump Cover CW.123.751



VOLVO : 3094835
WABCO : 895 073 589 4

CB.101.000

 VOLVO
 1508996
 5001477

 KNORR-BREMSE
 286104
 TUFLO 501

VEHICLE APPLICATION

 F7 / FS7 / FL7
 B58 / N10 / F86
 F6 / F10 / F12

Cylinder Bore	Ø66.675 mm	Number of Cylinders	2	Water or Air Cooled	Water	Unloader Port Size	1/8" NPT
Stroke	38.10 mm	Air Inlet Port Size	-	Through Drive	Pulley	Water Inlet Port Size	1/2" NPT
Swept Volume	265 cm ³	Air Delivery Port Size	Ø22.50 mm	With ESS System	Yes	Water Delivery Port Size	1/2" NPT

Complete Cylinderhead

CB.101.100

BENDIX : 282070

Discharge Valve Seat Kit

CB.101.908

2 PCS PER SET



BENDIX : 794751

Inlet Valve Seat Kit

CB.101.907

2 PCS PER SET



BENDIX : 736118

Repair Kit

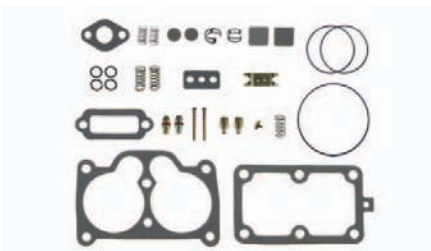
CB.101.903

Repair Kit

CB.101.912

BENDIX : 279615

Repair Kit

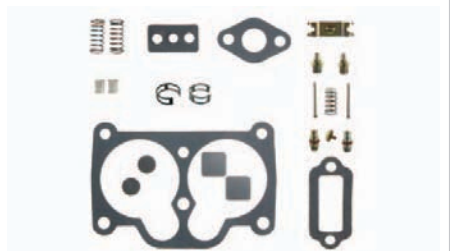
CB.101.913

BENDIX : 787043



Piston & Ring

66.68 mm CB.101.350

66.93 mm CB.101.960

67.18 mm CB.101.970

Piston

66.68 mm CB.101.351

66.93 mm CB.101.961

67.18 mm CB.101.971

Ring

66.68 mm CB.101.352

66.93 mm CB.101.962

67.18 mm CB.101.972

Crankcase

CB.101.4010

BENDIX : 249360

Connecting Rod

CB.101.500

BENDIX : 286259

Connecting Rod Bearing

CB.101.507

Crankshaft

CB.101.601

BENDIX : 246500

Flange Cover

CB.103.700

BENDIX : 290098A

Sump Cover

CB.101.751

Bushing

CB.101.708

BENDIX : 246430

Rear Cover

CB.101.720

BENDIX : 245471

CB.102.000

 VOLVO
 1590649
 1594266
 5002295

 KNORR-BREMSE
 289257
 TUFLO 700

VEHICLE APPLICATION

 F7 / FS7 / FL7
 B58 / N10 / F86
 F6 / F10 / F12

Cylinder Bore	Ø69.85 mm	Number of Cylinders	2	Water or Air Cooled	Water	Unloader Port Size	1/8" NPT
Stroke	46.00 mm	Air Inlet Port Size	-	Through Drive	Pulley	Water Inlet Port Size	1/2" NPT
Swept Volume	352 cm ³	Air Delivery Port Size	Ø22.50 mm	With ESS System	Yes	Water Delivery Port Size	1/2" NPT

Complete Cylinderhead

CB.102.100

BENDIX : 292485

Discharge Valve Seat Kit

CB.101.908

2 PCS PER SET



BENDIX : 794751

Inlet Valve Seat Kit

CB.101.907

2 PCS PER SET



BENDIX : 736118

Repair Kit

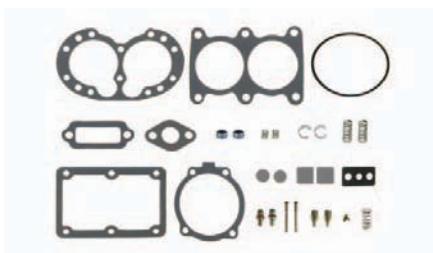
CB.102.903

Repair Kit

CB.101.912

BENDIX : 279615

Repair Kit

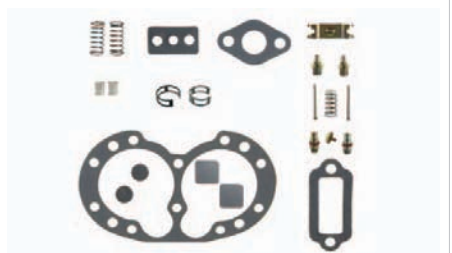
CB.102.913

BENDIX : 729417



Piston & Ring

69.85 mm CB.102.350

70.10 mm CB.102.960

70.35 mm CB.102.970

Piston

69.85 mm CB.102.351

70.10 mm CB.102.961

70.35 mm CB.102.971

Ring

69.85 mm CB.102.352

70.10 mm CB.102.962

70.35 mm CB.102.972

Crankcase CB.102.4010

BENDIX : 289697

Connecting Rod CB.102.500

BENDIX : 272720 / 289186

Connecting Rod Bearing CB.108.507

BENDIX : 238596 / 282767

Crankshaft CB.102.601

BENDIX : 292785

Cylinder Liner CB.102.3010

BENDIX : 238629

Ball Bearing CB.102.413

6207

BENDIX : 236120

Ball Bearing CB.102.4131

6011

BENDIX : 235440

Rear Cover CB.102.720

BENDIX : 273228

Sump Cover CB.102.751

CB.103.000

 VOLVO
 1080437
 1612335
 1570594
 5001711
 1590264
 8112780
 1188844

 KNORR-BREMSE
 KZ433/1RM
 1186722

VEHICLE APPLICATION

 FL7 / FL10 / FL12
 F10 / F12 / F16
 NL10 / NL12
 B10 / B58

Cylinder Bore	Ø75.00	Number of Cylinders	2	Water or Air Cooled	Water	Unloader Port Size	-
Stroke	50 mm	Air Inlet Port Size	M26x1,5	Through Drive	Gear	Water Inlet Port Size	M16x1,5
Swept Volume	440 cm ³	Air Delivery Port Size	M26x1,5	With ESS System	-	Water Delivery Port Size	M16x1,5

Complete Cylinderhead

CB.103.100

Cylinder Head

CB.103.1020



VOLVO : 3090472

Valve Plate

CB.103.1040

VOLVO : 3090473

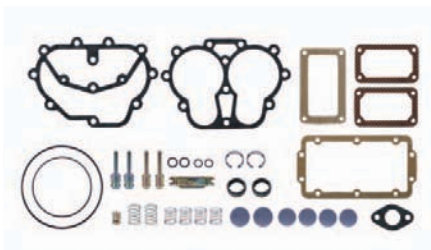
Repair Kit

CB.103.903

Gasket Kit

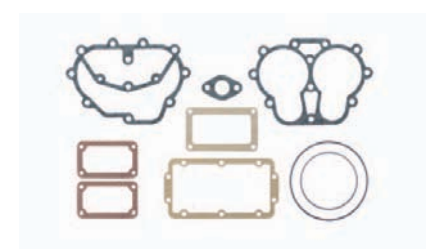
CB.103.905

Repair Kit

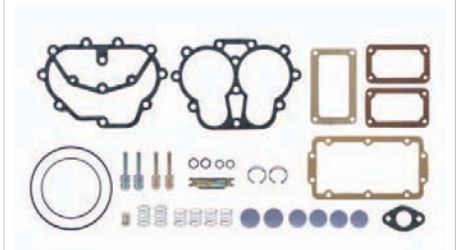
CB.103.912

 VOLVO : 3090471 / 272665 / 270698
 KNORR-BREMSE : I810150061



Piston & Ring 75.00 mm CB.103.350

2.38+2.38+3.94

75.25 mm CB.103.960

75.50 mm CB.103.970



VOLVO : 3094151

Piston 75.00 mm CB.103.351

75.25 mm CB.103.961

75.50 mm CB.103.971



VOLVO : 1697706

Ring 75.00 mm CB.103.352

2.38+2.38+3.94

75.25 mm CB.103.962

75.50 mm CB.103.972



VOLVO : 3094155

Crankcase **CB.103.400**



Connecting Rod **CB.103.500**



VOLVO : 3090257 / 1518356
KNORR-BREMSE : KW3127-1

Crankshaft **CB.103.601**



VOLVO : 1518353
KNORR-BREMSE : KY1564-1

Bushing **CB.103.727**

39x35x25



VOLVO : 1518350

Rear Cover **CB.103.720**

Aluminum Bushing Cover



VOLVO : 3090239
KNORR-BREMSE : KY1223-11

Ball Bearing **6207**



VOLVO : 111014

Valve Seat Kit **CB.103.914**



VOLVO : 1518347

Full Repair Kit **CB.103.901**



CB.122.000

 VOLVO
 9001611815
 1599919
 1611815
 5001153
 341453

 KNORR-BREMSE
 280737
 TUFLO 500

VEHICLE APPLICATION

 B58 / B55
 F7 / F10 / F12

Cylinder Bore	Ø63.50 mm	Number of Cylinders	2	Water or Air Cooled	Water	Unloader Port Size	1/8" NPT
Stroke	46.00 mm	Air Inlet Port Size	-	Through Drive	Pulley	Water Inlet Port Size	3/8" NPT
Swept Volume	292 cm ³	Air Delivery Port Size	Ø22.50 mm	With ESS System	Yes	Water Delivery Port Size	1/2" NPT

 Complete Cylinderhead **CB.102.100**

BENDIX : 292485

 Discharge Valve Seat Kit **CB.101.914**

2 PCS PER SET



BENDIX : 794751

 Inlet Valve Seat Kit **CB.101.915**

2 PCS PER SET

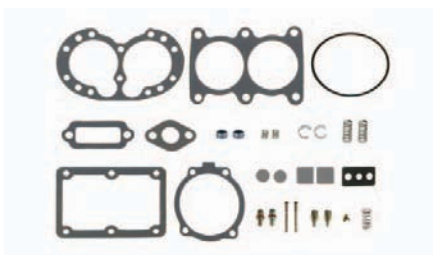

BENDIX : 736118

 Repair Kit **CB.102.903**

 Repair Kit **CB.101.912**

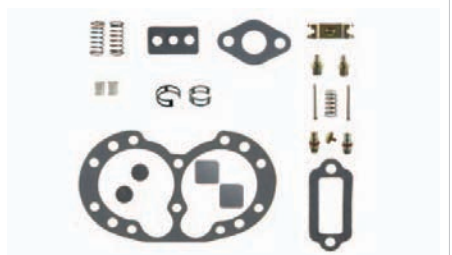
BENDIX : 779615

 Repair Kit **CB.102.913**

BENDIX : 729417



Piston & Ring

63.50 mm CB.122.350

63.75 mm CB.122.960

64.00 mm CB.122.970

Piston

63.50 mm CB.122.351

63.75 mm CB.122.961

64.00 mm CB.122.971

Ring

63.50 mm CB.122.352

63.75 mm CB.122.962

64.00 mm CB.122.972

Crankcase CB.102.400

BENDIX : 289697

Connecting Rod CB.102.500

BENDIX : 272720 / 229084

Connecting Rod Bearing CB.108.507

BENDIX : 238596 / 282767

Crankshaft CB.102.601

BENDIX : 292785

Cylinder Liner CB.122.3010

Ball Bearing 6207

BENDIX : 236120

Ball Bearing 6011

BENDIX : 235440

Rear Cover CB.102.720

BENDIX : 273228

Sump Cover CB.102.751

CK.106.000

 VOLVO
 8113633
 70305889
 70330081
 70330001
 85000194
 85000080
 8113565
 70303443

 KNORR-BREMSE
 LK4918
 LP4993

VEHICLE APPLICATION

 B10B / B10BLE
 B10L / B10LA
 B10M / B10MA

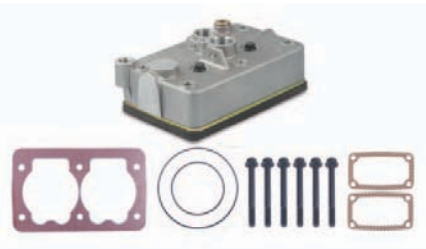

Cylinder Bore	Ø88.00	Number of Cylinders	2	Water or Air Cooled	Water	Unloader Port Size	-
Stroke	50 mm	Air Inlet Port Size	Ø29	Through Drive	Gear	Water Inlet Port Size	M16x1,5
Swept Volume	608 cm ³	Air Delivery Port Size	M26x1,5	With ESS System	-	Water Delivery Port Size	M16x1,5

Complete Cylinderhead

CK.106.1000

Cylinderhead

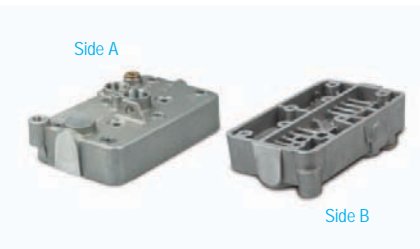
CK.106.1010

 LK4918 / LK4919 / LK4921 / LK4927 / LP4986 / LP4990
 LP4993 / LP4996 / LP4997

 VOLVO : 3095839
 KNORR-BREMSE : SEB01551004

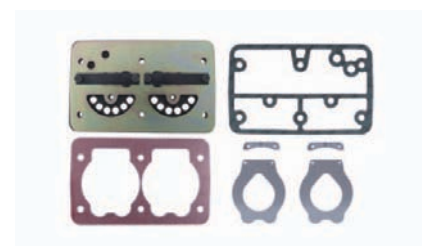
Complete Valve Plate

CK.106.200

 VOLVO : 3097146
 KNORR-BREMSE : SEB01033004

Valve Plate

CK.106.2010

Repair Kit

CK.106.903

KNORR-BREMSE : SEB22556

Repair Kit

CK.106.904



Piston & Ring 88.00 mm CK.116.350

2.50+2.50+4.00

88.25 mm CK.116.960

88.50 mm CK.116.970

VOLVO : 85101375 / 3095841 / 1698848
KNORR-BREMSE : SEB22555

Piston 88.00 mm CK.116.351

88.25 mm CK.116.961

88.50 mm CK.116.971

Ring 88.00 mm CK.116.352

2.50+2.50+4.00

88.25 mm CK.116.962

88.50 mm CK.116.972

VOLVO : 85100626 / 3097153
KNORR-BREMSE : II39526F0061

Crankcase CK.106.400

Connecting Rod CK.116.500

VOLVO : 3097151
KNORR-BREMSE : SEB00967004

Crankshaft CK.116.601

Bushing CK.116.434

42x38x25

VOLVO : 1697278 / 1697286
KNORR-BREMSE : EB00819

Rear Cover CK.116.720

Aluminum Bushing Cover

VOLVO : 3097150
KNORR-BREMSE : II159920065

Gasket Kit CK.106.905

VOLVO : 3095840
KNORR-BREMSE : SEB22557

Valve Kit CK.106.906

Repair Kit CK.106.910

Nut MC202061FX

M20x1.5 Right Hand

VOLVO : 1698672

CK.108.000

 VOLVO
 1599999
 5003217

 KNORR-BREMSE
 LP4812
 I86909

VEHICLE APPLICATION

 B6 / B7 / B10 / B12
 F16
 FL10 / FL6 / FL7
 FS7

Cylinder Bore	Ø75.00	Number of Cylinders	2	Water or Air Cooled	Water	Unloader Port Size	-
Stroke	50 mm	Air Inlet Port Size	M26x1,5	Through Drive	Gear	Water Inlet Port Size	M16x1,5
Swept Volume	440 cm ³	Air Delivery Port Size	M26x1,5	With ESS System	-	Water Delivery Port Size	M16x1,5

Complete Cylinderhead

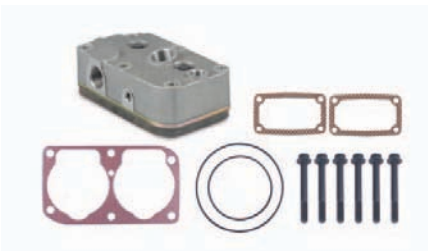
CK.108.1000

Cylinderhead

CK.108.1010

 VOLVO : 1697771
 KNORR-BREMSE : SEB00421004

Complete Valve Plate

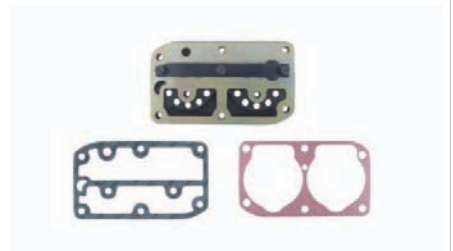
CK.108.200

 VOLVO : 1697770 / 1697290
 KNORR-BREMSE : I81015004

Valve Plate

CK.108.2010

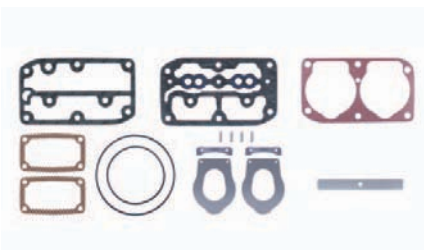
Repair Kit

CK.108.903

KNORR-BREMSE : SEB22541

Repair Kit

CK.108.904



Piston & Ring 75.00 mm CK.108.350

2.00+2.00+4.00

75.25 mm CK.108.960

75.50 mm CK.108.970

VOLVO : 1697282
KNORR-BREMSE : SEB22539 / SEB22540

Piston 75.00 mm CK.108.351

75.25 mm CK.108.961

75.50 mm CK.108.971

Ring 75.00 mm CW.108.352

2.00+2.00+4.00

75.25 mm CW.108.962

75.50 mm CW.108.972

VOLVO : 3090388
KNORR-BREMSE : I801770061

Crankcase CK.108.400

Connecting Rod CK.108.500

VOLVO : 1697281 / 1698528 / 3090386
KNORR-BREMSE : SEB00626004 / SEB00957004

Crankshaft CK.108.601

VOLVO : 1697285
KNORR-BREMSE : EB007622V / EB00762

Bushing CK.116.434

42x38x25

VOLVO : 1697278 / 1697286
KNORR-BREMSE : EB00819

Rear Cover CK.108.720

Aluminum Bushing Cover

VOLVO : 3090385 / 1697769
KNORR-BREMSE : SEB00387004

Gasket Kit CK.108.905

KNORR-BREMSE : SEB22542

Valve Kit CK.108.906

KNORR-BREMSE : I1326840061

Repair Kit CK.108.911

Nut MC202061FX

VOLVO : 1698672

CK.109.000

 VOLVO
 1613632
 5003336

 KNORR-BREMSE
 LP4813
 I90499

VEHICLE APPLICATION

 B6 / B7 / B10 / B12
 F16
 FL10 / FL6 / FL7
 FS7

Cylinder Bore	Ø75.00	Number of Cylinders	2	Water or Air Cooled	Water	Unloader Port Size	-
Stroke	50 mm	Air Inlet Port Size	M26x1,5	Through Drive	Gear	Water Inlet Port Size	M16x1,5
Swept Volume	440 cm ³	Air Delivery Port Size	M26x1,5	With ESS System	-	Water Delivery Port Size	M16x1,5

Complete Cylinderhead

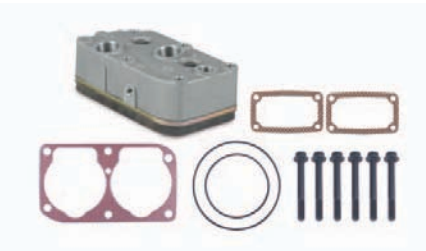
CK.109.1000

Cylinderhead

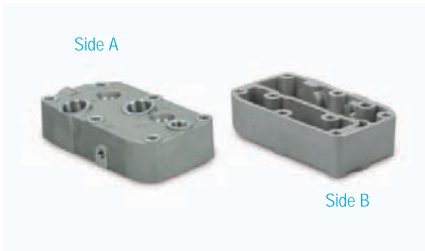
CK.109.1010

 VOLVO : 1698156
 KNORR-BREMSE : SEB00551004 / SEB22592

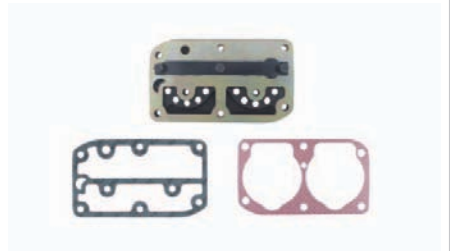
Complete Valve Plate

CK.108.200

 VOLVO : 1697770 / 1697290
 KNORR-BREMSE : I81015004

Valve Plate

CK.108.2010

Repair Kit

CK.108.903

KNORR-BREMSE : SEB22541

Repair Kit

CK.108.904





Piston & Ring 75.00 mm CK.108.350

2.00+2.00+4.00

75.25 mm CK.108.960

75.50 mm CK.108.970



VOLVO : 1697282
KNORR-BREMSE : SEB22539 / SEB22540

Piston 75.00 mm CK.108.351

75.25 mm CK.108.961

75.50 mm CK.108.971



Ring 75.00 mm CW.108.352

2.00+2.00+4.00

75.25 mm CW.108.962

75.50 mm CW.108.972



VOLVO : 3090388
KNORR-BREMSE : I801770061

Crankcase CK.108.400



Connecting Rod CK.108.500



VOLVO : 1697281 / 1698528 / 3090386
KNORR-BREMSE : SEB00626004 / SEB00957004

Crankshaft CK.108.601



VOLVO : 1697285
KNORR-BREMSE : EB007622V / EB00762

Bushing CK.116.434

42x38x25



VOLVO : 1697278 / 1697286
KNORR-BREMSE : EB00819

Rear Cover CK.108.720

Aluminum Bushing Cover



VOLVO : 3090385 / 1697769
KNORR-BREMSE : SEB00387004

Gasket Kit CK.108.905



KNORR-BREMSE : SEB22542

Valve Kit CK.108.906



KNORR-BREMSE : I1326840061

Repair Kit CK.108.911



Nut MC202061FX



VOLVO : 1698672

CK.112.000

 VOLVO
 8150407
 8112427

 KNORR-BREMSE
 LP4825
 II15993

VEHICLE APPLICATION

 FL10
 FL12
 F12
 F16
 FL6
 NL10
 NL12
 B10M
 B58

Cylinder Bore	Ø75.00	Number of Cylinders	2	Water or Air Cooled	Water	Unloader Port Size	M22x1,5
Stroke	50 mm	Air Inlet Port Size	M26x1,5	Through Drive	Gear	Water Inlet Port Size	M16x1,5
Swept Volume	440 cm ³	Air Delivery Port Size	M26x1,5	With ESS System	Yes	Water Delivery Port Size	M16x1,5

Complete Cylinderhead

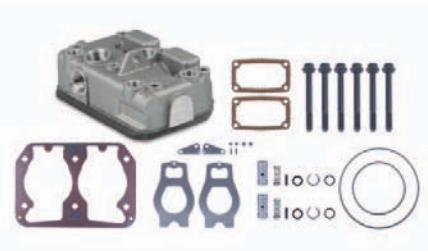
CK.112.1000

Cylinderhead

CK.112.1010

 VOLVO : 3090378
 KNORR-BREMSE : SEB01080004

Complete Valve Plate

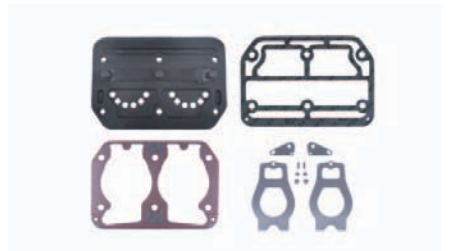
CK.112.200

 VOLVO : 3090380
 KNORR-BREMSE : SEB01081004

Valve Plate

CK.112.2010

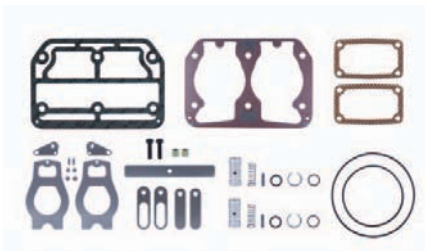
Repair Kit

CK.112.903

Repair Kit

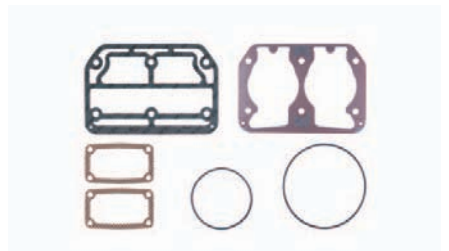
CK.112.905

 VOLVO : 3090377
 KNORR-BREMSE : II159930051



Piston & Ring 75.00 mm CK.108.350

2.00+2.00+4.00

75.25 mm CK.108.960

75.50 mm CK.108.970



VOLVO : 1697282
KNORR-BREMSE : SEB22539 / SEB22540

Piston 75.00 mm CK.108.351

75.25 mm CK.108.961

75.50 mm CK.108.971



Ring 75.00 mm CW.108.352

2.00+2.00+4.00

75.25 mm CW.108.962

75.50 mm CW.108.972



VOLVO : 3090388
KNORR-BREMSE : I801770061

Crankcase CK.112.400



Connecting Rod CK.108.500



VOLVO : 1697281 / 1698528 / 3090386
KNORR-BREMSE : SEB00626004 / SEB00957004

Crankshaft CK.108.601



VOLVO : 1697285
KNORR-BREMSE : EB007622V / EB00762

Bushing CK.116.434

42x38x25



VOLVO : 1697278 / 1697286
KNORR-BREMSE : EB00819

Rear Cover CK.108.720

Aluminum Bushing Cover



VOLVO : 3090385 / 1697769
KNORR-BREMSE : SEB00387004

Valve Kit CK.112.907



VOLVO : 3091740
KNORR-BREMSE : I1326850061

Valve Kit CK.112.908



VOLVO : 3091591
KNORR-BREMSE : SEB010800061

Repair Kit CK.112.912

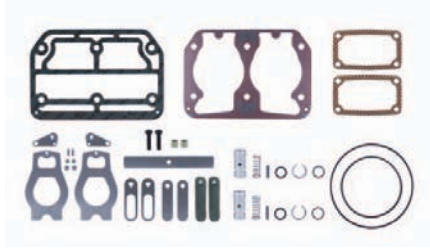

Repair Kit CK.116.921



VOLVO : 3097147
KNORR-BREMSE : I1159920063

CK.113.000

 VOLVO
 1628593
 8112594

 KNORR-BREMSE
 LP4930
 II15698

VEHICLE APPLICATION

 FH12
 FM16
 NH12
 B12

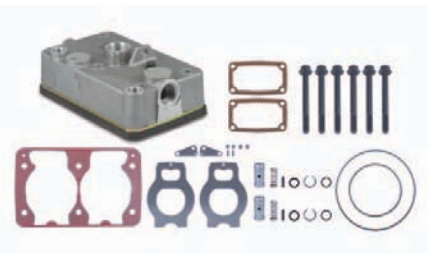

Cylinder Bore	Ø88.00	Number of Cylinders	2	Water or Air Cooled	Water	Unloader Port Size	M22x1,5
Stroke	50 mm	Air Inlet Port Size	Ø29	Through Drive	Gear	Water Inlet Port Size	M16x1,5
Swept Volume	608 cm ³	Air Delivery Port Size	M26x1,5	With ESS System	Yes	Water Delivery Port Size	M16x1,5

Complete Cylinderhead

CK.117.1000

KNORR-BREMSE : SEB05052004

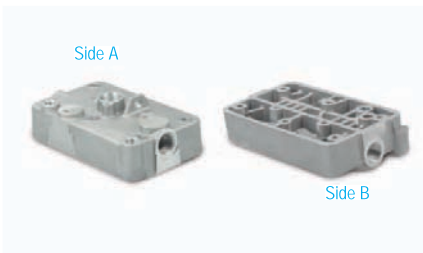
Cylinderhead

CK.117.1010

 VOLVO : 1699820
 KNORR-BREMSE : SEB01138004

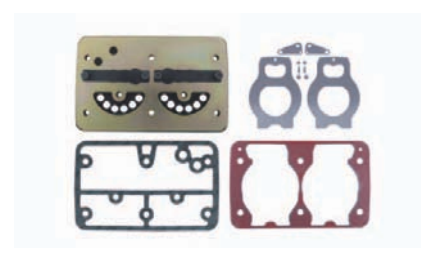
Complete Valve Plate

CK.116.200

 VOLVO : 3097146
 KNORR-BREMSE : SEB01033004

Valve Plate

CK.116.2010

Repair Kit

CK.116.903

Repair Kit

CK.116.905





Piston & Ring 88.00 mm CK.116.350

2.50+2.50+4.00

88.25 mm CK.116.960

88.50 mm CK.116.970



VOLVO : 85101375 / 3095841 / 1698848
 KNORR-BREMSE : SEB22555

Piston 88.00 mm CK.116.351

88.25 mm CK.116.961

88.50 mm CK.116.971



Ring 88.00 mm CK.116.352

2.50+2.50+4.00

88.25 mm CK.116.962

88.50 mm CK.116.972



VOLVO : 85100626 / 3097153
 KNORR-BREMSE : II39526F0061

Crankcase CK.113.400



Connecting Rod CK.116.500



VOLVO : 3097151
 KNORR-BREMSE : SEB00967004

Crankshaft CK.117.601



Bushing CK.116.434

42x38x25



VOLVO : 1697278 / 1697286
 KNORR-BREMSE : EB00819

Rear Cover CK.116.720

Aluminum Bushing Cover



VOLVO : 3097150
 KNORR-BREMSE : II159920065

Valve Kit CK.116.907



VOLVO : 3091739
 KNORR-BREMSE : II326840061

Valve Kit CK.116.908



VOLVO : 3091718
 KNORR-BREMSE : SEB01138004 / SEB011380061

Repair Kit CK.116.912



Repair Kit CK.116.921



VOLVO : 3097147
 KNORR-BREMSE : II159920063

CK.114.000

 VOLVO
 3037346
 8112543

 KNORR-BREMSE
 LP4934
 II15992

VEHICLE APPLICATION

 B10B
 B10L
 B10M
 B10BLE
 B10LA

Cylinder Bore	Ø88.00	Number of Cylinders	2	Water or Air Cooled	Water	Unloader Port Size	M22x1,5
Stroke	50 mm	Air Inlet Port Size	Ø29	Through Drive	Gear	Water Inlet Port Size	M16x1,5
Swept Volume	608 cm ³	Air Delivery Port Size	M26x1,5	With ESS System	Yes	Water Delivery Port Size	M16x1,5

Complete Cylinderhead

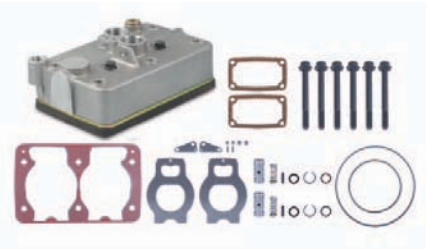
CK.116.1000

Cylinderhead

CK.116.1010

FIT LP4934 / LP4949 / LP4960 / LP4967 / LP4968

 VOLVO : 3097144
 KNORR-BREMSE : SEB01052004

Complete Valve Plate

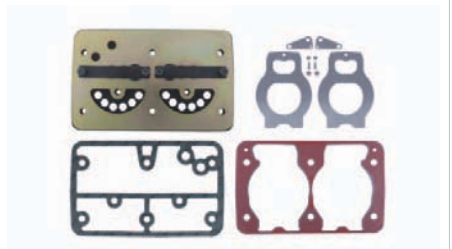
CK.116.200

 VOLVO : 3097146
 KNORR-BREMSE : SEB01033004

Valve Plate

CK.116.2010

Repair Kit

CK.116.903

Repair Kit

CK.116.905



Piston & Ring 88.00 mm CK.116.350

2.50+2.50+4.00

88.25 mm CK.116.960

88.50 mm CK.116.970

VOLVO : 85101375 / 3095841 / 1698848
KNORR-BREMSE : SEB22555

Piston 88.00 mm CK.116.351

88.25 mm CK.116.961

88.50 mm CK.116.971

Ring 88.00 mm CK.116.352

2.50+2.50+4.00

88.25 mm CK.116.962

88.50 mm CK.116.972

VOLVO : 85100626 / 3097153
KNORR-BREMSE : I139526F0061

Crankcase CK.114.400

Connecting Rod CK.116.500

VOLVO : 3097151
KNORR-BREMSE : SEB00967004

Crankshaft CK.116.601

Bushing CK.116.434

42x38x25

VOLVO : 1697278 / 1697286
KNORR-BREMSE : EB00819

Rear Cover CK.116.720

Aluminum Bushing Cover

VOLVO : 3097150
KNORR-BREMSE : I1159920065

Valve Kit CK.116.907

VOLVO : 3091739
KNORR-BREMSE : I1326840061

Valve Kit CK.116.908

VOLVO : 3091718
KNORR-BREMSE : SEB01138004 / SEB011380061

Repair Kit CK.116.912

Repair Kit CK.116.921

VOLVO : 3097147
KNORR-BREMSE : I1159920063

CK.116.000

 VOLVO
 8113023
 9521675

 KNORR-BREMSE
 LP4967
 II33164

VEHICLE APPLICATION

 B10B
 B10L
 B10M

Cylinder Bore	Ø88.00	Number of Cylinders	2	Water or Air Cooled	Water	Unloader Port Size	M22x1,5
Stroke	50 mm	Air Inlet Port Size	Ø29	Through Drive	Gear	Water Inlet Port Size	M16x1,5
Swept Volume	608 cm ³	Air Delivery Port Size	M26x1,5	With ESS System	Yes	Water Delivery Port Size	M16x1,5

Complete Cylinderhead

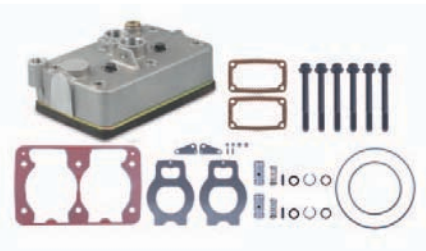
CK.116.1000

Cylinderhead

CK.116.1010

FIT LP4934 / LP4949 / LP4960 / LP4967 / LP4968

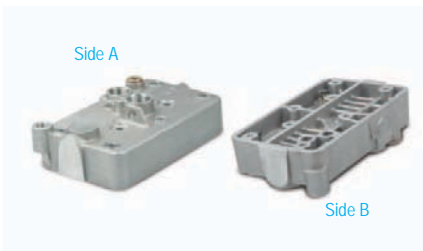
 VOLVO : 3097144
 KNORR-BREMSE : SEB01052004

Complete Valve Plate

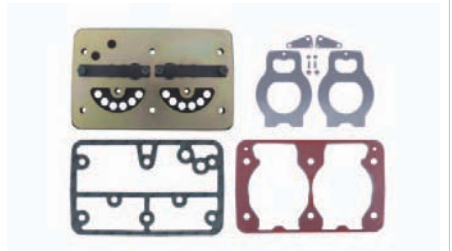
CK.116.200

 VOLVO : 3097146
 KNORR-BREMSE : SEB01033004

Valve Plate

CK.116.2010

Repair Kit

CK.116.903

Repair Kit

CK.116.905



Piston & Ring 88.00 mm CK.116.350

2.50+2.50+4.00

88.25 mm CK.116.960

88.50 mm CK.116.970

VOLVO : 85101375 / 3095841 / 1698848
 KNORR-BREMSE : SEB22555

Piston 88.00 mm CK.116.351

88.25 mm CK.116.961

88.50 mm CK.116.971

Ring 88.00 mm CK.116.352

2.50+2.50+4.00

88.25 mm CK.116.962

88.50 mm CK.116.972

VOLVO : 85100626 / 3097153
 KNORR-BREMSE : I139526F0061

Crankcase CK.116.400

Connecting Rod CK.116.500

VOLVO : 3097151
 KNORR-BREMSE : SEB00967004

Crankshaft CK.116.601

Bushing CK.116.434

42x38x25

VOLVO : 1697278 / 1697286
 KNORR-BREMSE : EB00819

Rear Cover CK.116.720

Aluminum Bushing Cover

VOLVO : 3097150
 KNORR-BREMSE : I1159920065

Valve Kit CK.116.907

VOLVO : 3091739
 KNORR-BREMSE : I1326840061

Valve Kit CK.116.908

VOLVO : 3091718
 KNORR-BREMSE : SEB01138004 / SEB011380061

Repair Kit CK.116.912

Repair Kit CK.116.921

VOLVO : 3097147
 KNORR-BREMSE : I1159920063

CK.117.000

 VOLVO
 20429339
 3987602
 85000064

 KNORR-BREMSE
 LP4974
 II37214

VEHICLE APPLICATION

 FH12
 FM16
 NH12
 B12

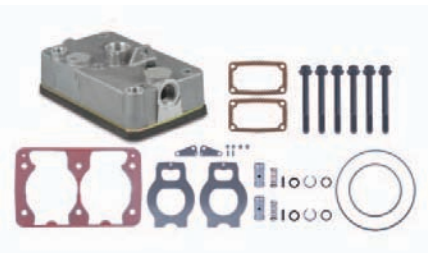

Cylinder Bore	Ø88.00	Number of Cylinders	2	Water or Air Cooled	Water	Unloader Port Size	M22x1,5
Stroke	50 mm	Air Inlet Port Size	Ø29	Through Drive	Gear	Water Inlet Port Size	M16x1,5
Swept Volume	608 cm ³	Air Delivery Port Size	M26x1,5	With ESS System	Yes	Water Delivery Port Size	M16x1,5

Complete Cylinderhead

CK.117.1000

KNORR-BREMSE : SEB05052004

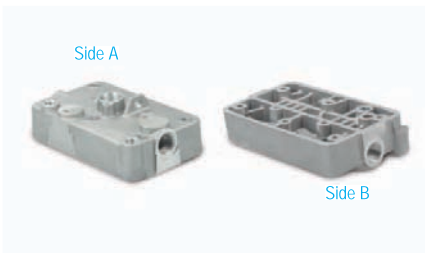
Cylinderhead

CK.117.1010

 VOLVO : 1699820
 KNORR-BREMSE : SEB01138004

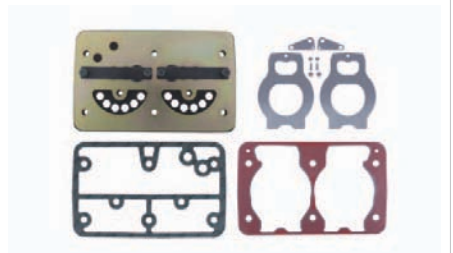
Complete Valve Plate

CK.116.200

 VOLVO : 3097146
 KNORR-BREMSE : SEB01033004

Valve Plate

CK.116.2010

Repair Kit

CK.116.903

Repair Kit

CK.116.905

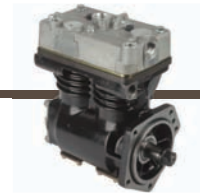



Piston & Ring 88.00 mm CK.116.350

2.50+2.50+4.00

88.25 mm CK.116.960

88.50 mm CK.116.970



VOLVO : 85101375 / 3095841 / 1698848
KNORR-BREMSE : SEB22555

Piston 88.00 mm CK.116.351

88.25 mm CK.116.961

88.50 mm CK.116.971



Ring 88.00 mm CK.116.352

2.50+2.50+4.00

88.25 mm CK.116.962

88.50 mm CK.116.972



VOLVO : 85100626 / 3097153
KNORR-BREMSE : I139526F0061

Crankcase CK.117.400



Connecting Rod CK.116.500



VOLVO : 3097151
KNORR-BREMSE : SEB00967004

Crankshaft CK.117.601



Bushing CK.116.434

42x38x25



VOLVO : 1697278 / 1697286
KNORR-BREMSE : EB00819

Rear Cover CK.116.720

Aluminum Bushing Cover



VOLVO : 3097150
KNORR-BREMSE : I1159920065

Valve Kit CK.116.907



VOLVO : 3091739
KNORR-BREMSE : I1326840061

Valve Kit CK.116.908



VOLVO : 3091718
KNORR-BREMSE : SEB01138004 / SEB011380061

Repair Kit CK.116.912



Repair Kit CK.116.921



VOLVO : 3097147
KNORR-BREMSE : I1159920063

CK.118.000

 VOLVO
 70330098
 85000199
 8113592
 70305894
 70330006
 85000085

 KNORR-BREMSE
 LP4992

VEHICLE APPLICATION

 FH12 / FH16
 FM7 / FM12
 NH12 / FL12
 B12 / B12B
 B12R / B7L

Cylinder Bore	Ø88.00	Number of Cylinders	2	Water or Air Cooled	Water	Unloader Port Size	-
Stroke	50 mm	Air Inlet Port Size	Ø29	Through Drive	Gear	Water Inlet Port Size	M16x1,5
Swept Volume	608 cm ³	Air Delivery Port Size	M26x1,5	With ESS System	-	Water Delivery Port Size	M16x1,5

Complete Cylinderhead

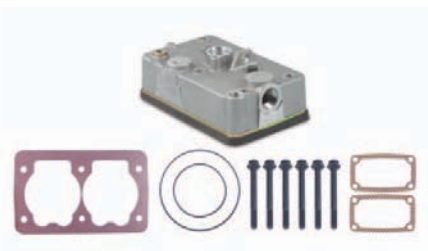
CK.118.1000

Cylinderhead

CK.118.1010

LK4920 / LP4985 / LP4988 / LP4991 / LP4992 / LP4995

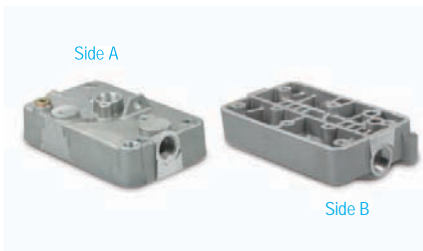
 VOLVO : 3095847
 KNORR-BREMSE : SEB01549004

Complete Valve Plate

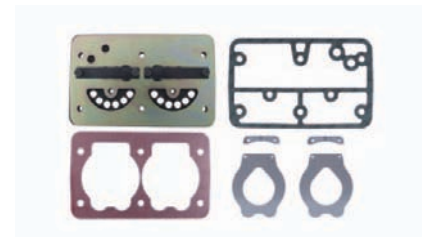
CK.106.200

 VOLVO : 3097146
 KNORR-BREMSE : SEB01033004

Valve Plate

CK.106.2010



Repair Kit

CK.106.903

KNORR-BREMSE : SEB22556

Repair Kit

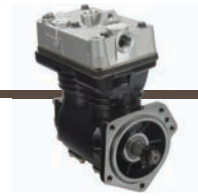
CK.106.904





Piston & Ring 88.00 mm CK.116.350

2.50+2.50+4.00

88.25 mm CK.116.960

88.50 mm CK.116.970



VOLVO : 85101375 / 3095841 / 1698848
KNORR-BREMSE : SEB22555

Piston 88.00 mm CK.116.351

88.25 mm CK.116.961

88.50 mm CK.116.971



Ring 88.00 mm CK.116.352

2.50+2.50+4.00

88.25 mm CK.116.962

88.50 mm CK.116.972



VOLVO : 85100626 / 3097153
KNORR-BREMSE : II39526F0061

Crankcase CK.118.400



Connecting Rod CK.116.500



VOLVO : 3097151
KNORR-BREMSE : SEB00967004

Crankshaft CK.117.601



Bushing CK.116.434

42x38x25



VOLVO : 1697278 / 1697286
KNORR-BREMSE : EB00819

Rear Cover CK.116.720

Aluminum Bushing Cover



VOLVO : 3097150
KNORR-BREMSE : II159920065

Gasket Kit CK.106.905



VOLVO : 3095840
KNORR-BREMSE : SEB22557

Valve Kit CK.106.906



Repair Kit CK.106.910



Nut MC202061FX

M20x1.5 Right Hand



VOLVO : 1698672

CK.121.000

 VOLVO
 20429343
 3173001
 8113405
 85000066

 KNORR-BREMSE
 LP4985
 II37760

VEHICLE APPLICATION

 FH12 / FH16
 FM7 / FM12
 NH12 / FL12
 B12 / B12B
 B12R / B7L

Cylinder Bore	Ø88.00	Number of Cylinders	2	Water or Air Cooled	Water	Unloader Port Size	-
Stroke	50 mm	Air Inlet Port Size	Ø29	Through Drive	Gear	Water Inlet Port Size	M16x1,5
Swept Volume	608 cm ³	Air Delivery Port Size	M26x1,5	With ESS System	-	Water Delivery Port Size	M16x1,5

Complete Cylinderhead

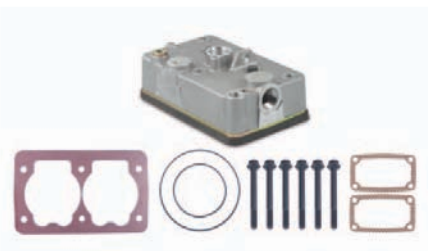
CK.118.1000

Cylinderhead

CK.118.1010

LK4920 / LP4985 / LP4988 / LP4991 / LP4992 / LP4995

 VOLVO : 3095847
 KNORR-BREMSE : SEB01549004

Complete Valve Plate

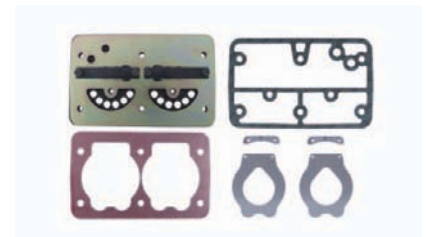
CK.106.200

 VOLVO : 3097146
 KNORR-BREMSE : SEB01033004

Valve Plate

CK.106.2010



Repair Kit

CK.106.903

KNORR-BREMSE : SEB22556

Repair Kit

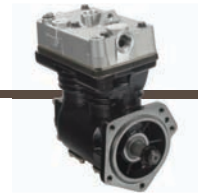
CK.106.904





Piston & Ring 88.00 mm CK.116.350

2.50+2.50+4.00

88.25 mm CK.116.960

88.50 mm CK.116.970



VOLVO : 85101375 / 3095841 / 1698848
 KNORR-BREMSE : SEB22555

Piston 88.00 mm CK.116.351

88.25 mm CK.116.961

88.50 mm CK.116.971



Ring 88.00 mm CK.116.352

2.50+2.50+4.00

88.25 mm CK.116.962

88.50 mm CK.116.972



VOLVO : 85100626 / 3097153
 KNORR-BREMSE : II39526F0061

Crankcase CK.118.400



Connecting Rod CK.116.500



VOLVO : 3097151
 KNORR-BREMSE : SEB00967004

Crankshaft CK.117.601



Bushing CK.116.434

42x38x25



VOLVO : 1697278 / 1697286
 KNORR-BREMSE : EB00819

Rear Cover CK.116.720

Aluminum Bushing Cover



VOLVO : 3097150
 KNORR-BREMSE : II159920065

Gasket Kit CK.106.905



VOLVO : 3095840
 KNORR-BREMSE : SEB22557

Valve Kit CK.106.906



Repair Kit CK.106.910



Nut MC202061FX

M20x1.5 Right Hand



VOLVO : 1698672

CK.127.000

 VOLVO
 8113634
 70305892
 70330094
 85000197
 85000083
 70330004
 8113567
 70303446
 8113484
 3194908

 KNORR-BREMSE
 LK4921
 LP4996
 LP4989

VEHICLE APPLICATION

 B10M / B10R / B10
 B12 / B6BLE
 SUPER OLYPIAN

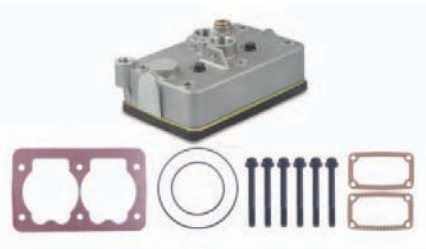

Cylinder Bore	Ø88.00	Number of Cylinders	2	Water or Air Cooled	Water	Unloader Port Size	-
Stroke	50 mm	Air Inlet Port Size	Ø29	Through Drive	Gear	Water Inlet Port Size	M16x1,5
Swept Volume	608 cm ³	Air Delivery Port Size	M26x1,5	With ESS System	-	Water Delivery Port Size	M16x1,5

Complete Cylinderhead

CK.106.1000

Cylinderhead

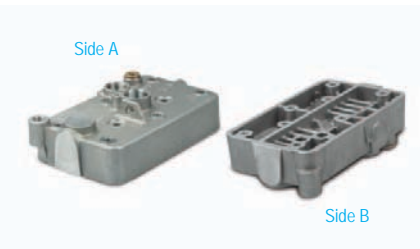
CK.106.1010

 LK4918 / LK4919 / LK4921 / LK4927 / LP4986 / LP4990
 LP4993 / LP4996 / LP4997

 VOLVO : 3095839
 KNORR-BREMSE : SEB01551004

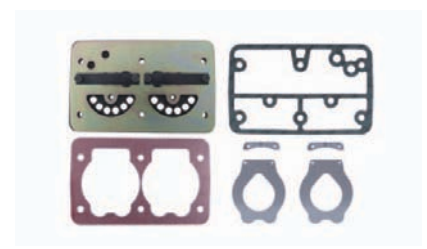
Complete Valve Plate

CK.106.200

 VOLVO : 3097146
 KNORR-BREMSE : SEB01033004

Valve Plate

CK.106.2010



Repair Kit

CK.106.903

KNORR-BREMSE : SEB22556

Repair Kit

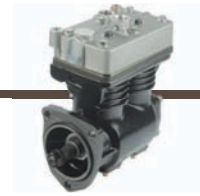
CK.106.904

Piston & Ring 88.00 mm CK.116.350

2.50+2.50+4.00

88.25 mm CK.116.960

88.50 mm CK.116.970

VOLVO : 85101375 / 3095841 / 1698848
KNORR-BREMSE : SEB22555

Piston 88.00 mm CK.116.351

88.25 mm CK.116.961

88.50 mm CK.116.971

Ring 88.00 mm CK.116.352

2.50+2.50+4.00

88.25 mm CK.116.962

88.50 mm CK.116.972

VOLVO : 85100626 / 3097153
KNORR-BREMSE : II39526F0061

Crankcase CK.127.400

Connecting Rod CK.116.500

VOLVO : 3097151
KNORR-BREMSE : SEB00967004

Crankshaft CK.116.601

Bushing CK.116.434

42x38x25

VOLVO : 1697278 / 1697286
KNORR-BREMSE : EB00819

Rear Cover CK.116.720

Aluminum Bushing Cover

VOLVO : 3097150
KNORR-BREMSE : II159920065

Gasket Kit CK.106.905

VOLVO : 3095840
KNORR-BREMSE : SEB22557

Valve Kit CK.106.906

Repair Kit CK.106.910

Nut MC202061FX

M20x1.5 Right Hand

VOLVO : 1698672

CK.132.000

 VOLVO
 8129779
 8113270
 8119270

 KNORR-BREMSE
 LP4850
 II35564

VEHICLE APPLICATION

 FL6
 FL7
 FL10

Cylinder Bore	Ø75.00	Number of Cylinders	2	Water or Air Cooled	Water	Unloader Port Size	-
Stroke	50 mm	Air Inlet Port Size	M26x1,5	Through Drive	Gear	Water Inlet Port Size	M16x1,5
Swept Volume	440 cm ³	Air Delivery Port Size	M26x1,5	With ESS System	-	Water Delivery Port Size	M16x1,5

Complete Cylinderhead

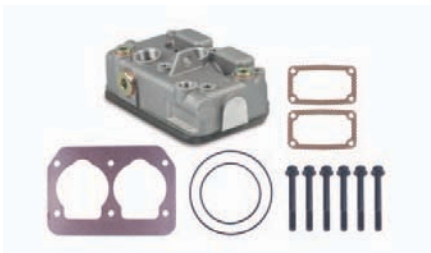
CK.132.1000

Cylinderhead

CK.132.1010

 VOLVO : 8127749
 KNORR-BREMSE : SEB0515004

Complete Valve Plate

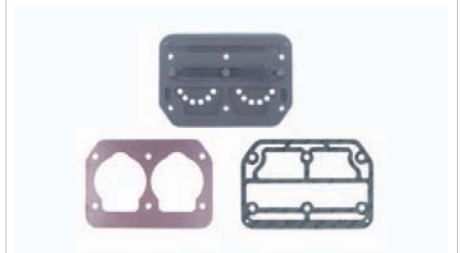
CK.132.200

 VOLVO : 8127751
 KNORR-BREMSE : SEB01000004

Valve Plate

CK.132.2010

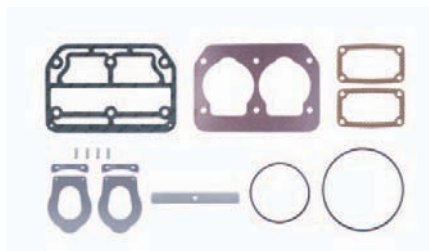
Repair Kit

CK.132.903

Repair Kit

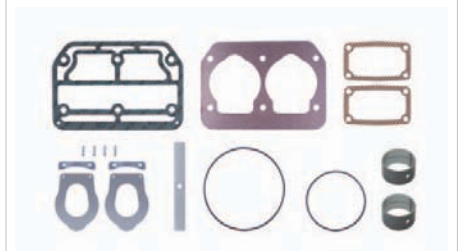
CK.132.904





Piston & Ring 75.00 mm CK.108.350

2.00+2.00+4.00

75.25 mm CK.108.960

75.50 mm CK.108.970



VOLVO : 1697282
KNORR-BREMSE : SEB22539 / SEB22540

Piston 75.00 mm CK.108.351

75.25 mm CK.108.961

75.50 mm CK.108.971



Ring 75.00 mm CW.108.352

2.00+2.00+4.00

75.25 mm CW.108.962

75.50 mm CW.108.972



VOLVO : 3090388
KNORR-BREMSE : I801770061

Crankcase CK.132.400



Connecting Rod CK.108.500



VOLVO : 1697281 / 1698528 / 3090386
KNORR-BREMSE : SEB00626004 / SEB00957004

Crankshaft CK.108.601



VOLVO : 1697285
KNORR-BREMSE : EB007622V / EB00762

Bushing CK.116.434

42x38x25



VOLVO : 1697278 / 1697286
KNORR-BREMSE : EB00819

Rear Cover CK.108.720

Aluminum Bushing Cover



VOLVO : 3090385 / 1697769
KNORR-BREMSE : SEB00387004

Gasket Kit CK.132.905



VOLVO : 8127750
KNORR-BREMSE : II156970051 / SEB22544

Valve Kit CK.108.906



KNORR-BREMSE : II326840061

Repair Kit CK.132.911



Nut MC202061FX



VOLVO : 1698672

CK.149.000

WABCO CYLINDER HEAD VERION

CK.278.000

KNORR-BREMSE CYLINDER HEAD VERION

 VOLVO
 6772239
 5003219
 085028

 KNORR-BREMSE
 LK3802
 I85028
VEHICLE APPLICATION
 F7
 FL7
**CK.149.000****CK.278.000**

*** CK.149.000 - WABCO Cylinder Head Version

*** CK.278.000 - KNORR-BREMSE Cylinder Head Version

Cylinder Bore	Ø88.00	Number of Cylinders	1	Water or Air Cooled	Water	Unloader Port Size	-
Stroke	35 mm	Air Inlet Port Size	M26x1,5	Through Drive	Gear	Water Inlet Port Size	-
Swept Volume	213 cm ³	Air Delivery Port Size	M26x1,5	With ESS System	-	Water Delivery Port Size	-

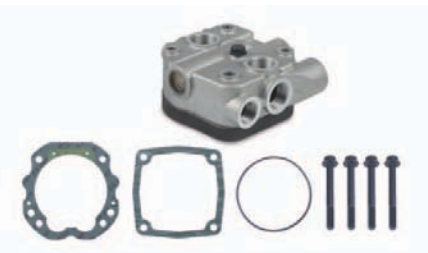
Complete Cylinderhead **CK.149.100**

WABCO : 411 033 806 2 / 411 033 801 2

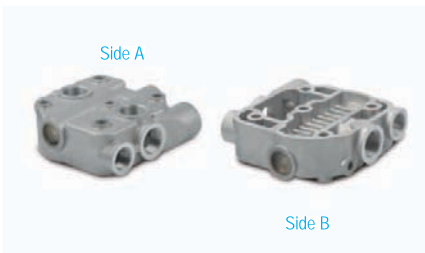
Cylinderhead **CK.149.1010**

WABCO : 411 033 653 2

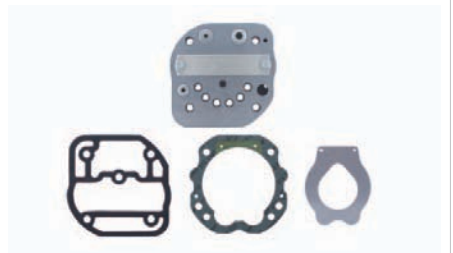
Complete Valve Plate **CK.149.200**

WABCO : 411 033 505 2 / 411 033 503 2

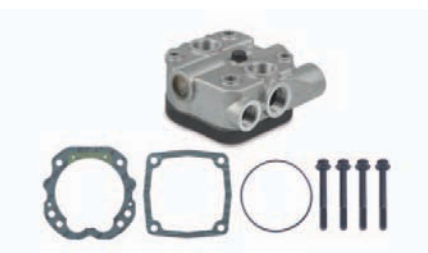
Complete Cylinderhead **CK.278.100**

KNORR-BREMSE : I90153004 / I93078004

Cylinderhead **CK.278.1010**

KNORR-BREMSE : STW63970 / ZB4275

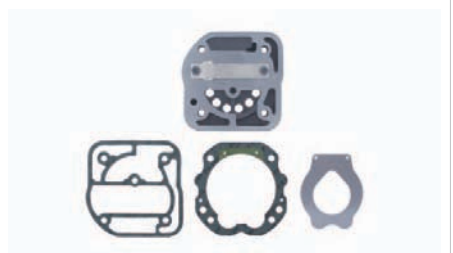
Complete Valve Plate **CK.278.200**

KNORR-BREMSE : I880570061 / I38715F004



Piston & Ring 88.00 mm CK.116.350

88.25 mm CK.116.960

88.50 mm CK.116.970

KNORR-BREMSE : SEB22555

Piston 88.00 mm CK.116.351

88.25 mm CK.116.961

88.50 mm CK.116.971

Ring 88.00 mm CW.116.352

2.00+2.00+4.00

88.25 mm CW.116.962

88.50 mm CW.116.972

Crankcase CK.149.400

Connecting Rod CK.102.500

VOLVO : 1698852
KNORR-BREMSE : B80110 / I60599

Crankshaft CK.149.601

VOLVO : 1697094
KNORR-BREMSE : I85022

Cylinder Liner & Piston CK.130.300

STD. Piston & Ring

KNORR-BREMSE : I80864/0061

Cylinder Liner CK.130.3010

VOLVO : 1697111
KNORR-BREMSE : C63059

Flange Cover CK.149.700

VOLVO : 1687207
KNORR-BREMSE : I80962

Bushing CK.102.708

34x30x16

KNORR-BREMSE : B64572

Repair Kit CK.149.903

Repair Kit CK.278.903

CK.172.000

 VOLVO
 6795600
 5003219

 KNORR-BREMSE
 LK3813
 I94314

VEHICLE APPLICATION

 F7
 FL7

Cylinder Bore	Ø88.00	Number of Cylinders	1	Water or Air Cooled	Water	Unloader Port Size	-
Stroke	37 mm	Air Inlet Port Size	M26x1,5	Through Drive	Gear	Water Inlet Port Size	-
Swept Volume	225 cm ³	Air Delivery Port Size	M26x1,5	With ESS System	-	Water Delivery Port Size	-

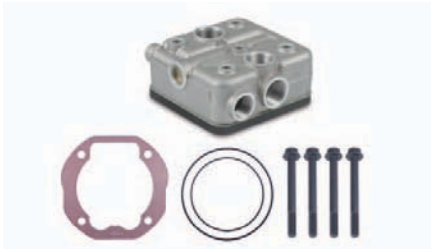
Complete Cylinderhead CK.172.100

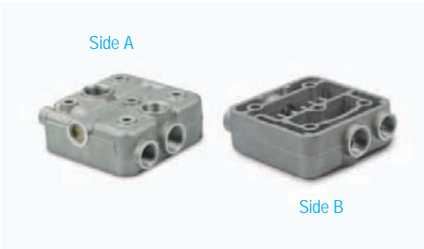
 VOLVO : 1698851
 KNORR-BREMSE : K021494K50

Cylinderhead CK.172.1010

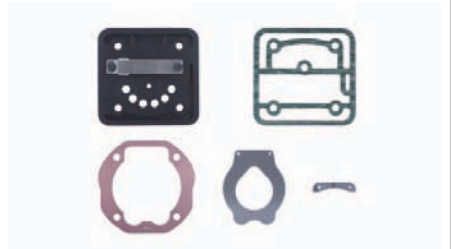
KNORR-BREMSE : I94672

Complete Valve Plate CK.172.200

 VOLVO : 276117 / 3099753
 KNORR-BREMSE : I94056004

Valve Plate CK.172.2010

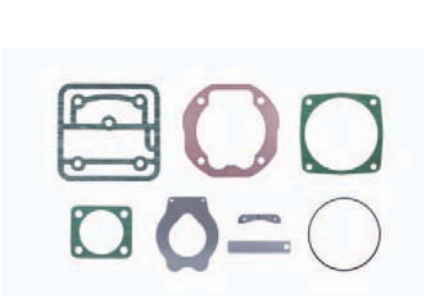
KNORR-BREMSE : I90153004 / I93078004

Repair Kit CK.172.903

KNORR-BREMSE : STW63970 / ZB4275

Repair Kit CK.172.904

KNORR-BREMSE : I880570061 / I38715F004



Piston & Ring 88.00 mm CK.116.350

88.25 mm CK.116.960

88.50 mm CK.116.970

KNORR-BREMSE : SEB22555

Piston 88.00 mm CK.116.351

88.25 mm CK.116.961

88.50 mm CK.116.971

Ring 88.00 mm CW.116.352

2.00+2.00+4.00

88.25 mm CW.116.962

88.50 mm CW.116.972

Crankcase CK.149.400

Connecting Rod CK.102.500

VOLVO : 1698852
KNORR-BREMSE : B80110 / I60599

Crankshaft CK.149.601

VOLVO : 1697094
KNORR-BREMSE : I85022

Cylinder Liner & Piston CK.130.300

STD. Piston & Ring

KNORR-BREMSE : I80864/0061

Cylinder Liner CK.130.3010

VOLVO : 1697111
KNORR-BREMSE : C63059

Flange Cover CK.149.700

VOLVO : 1687207
KNORR-BREMSE : I80962

Bushing CK.102.708

34x30x16

KNORR-BREMSE : B64572

Bushing CK.102.434

34x30x16

KNORR-BREMSE : B44935

Repair Kit CK.172.905

CK.173.000

 VOLVO
 21101027

 KNORR-BREMSE
 LK4954
 K017528
 K017528N57

VEHICLE APPLICATION
 B7R

Cylinder Bore	Ø92.00	Number of Cylinders	2	Water or Air Cooled	Water	Unloader Port Size	M10x1
Stroke	54 mm	Air Inlet Port Size	M26x1,5	Through Drive	Gear	Water Inlet Port Size	M18x1,5
Swept Volume	720 cm ³	Air Delivery Port Size	M22x1,5	With ESS System	Yes	Water Delivery Port Size	M18x1,5

Complete Cylinderhead

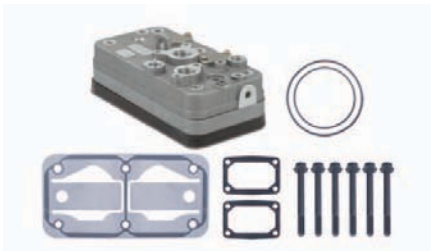
CK.173.1000

 VOLVO : 21136561
 KNORR-BREMSE : K017529

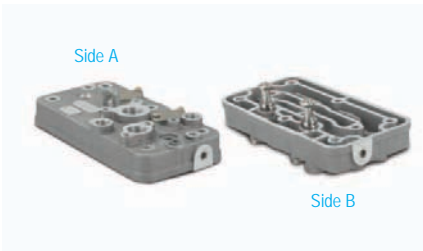
Cylinder Up Head

CK.173.1020

Cylinder Bottom Head

CK.173.1040

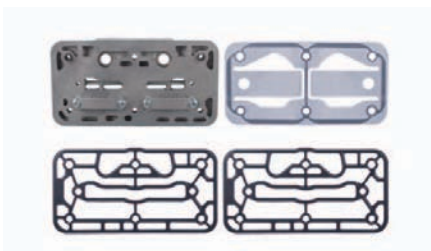

Complete Valve Plate

CK.173.200

 VOLVO : 21136726
 KNORR-BREMSE : K012074

Valve Plate

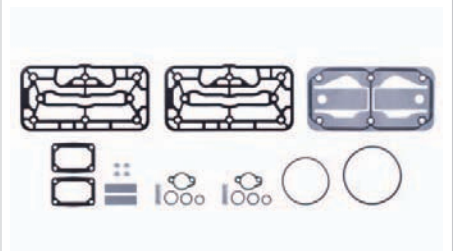
CK.173.2010

Repair Kit

CK.173.903



Piston & Ring 92.00 mm CK.173.350

2.50+2.50+4.00

92.25 mm CK.173.960

92.50 mm CK.173.970

KNORR-BREMSE : SEB22530 / K012079

Piston 92.00 mm CK.173.351

92.25 mm CK.173.961

92.50 mm CK.173.971

Ring 92.00 mm CK.165.352

2.50+2.50+4.00

92.25 mm CK.165.962

92.50 mm CK.165.972

Crankcase CK.173.400

Connecting Rod CK.173.500

Crankshaft CK.173.601

Bushing CK.116.434

42x38x25

VOLVO : 1697278 / 1697286
KNORR-BREMSE : EB00819

Rear Cover CK.173.720

Aluminum Bushing Cover

Repair Kit CK.173.901

Repair Kit CK.173.911

Repair Kit CK.173.913

KNORR-BREMSE : K012086

Valve Kit CK.173.921

KNORR-BREMSE : K034874K50

CK.185.000

 VOLVO
 20568594
 3181133
 85000345

 KNORR-BREMSE
 LP3970

VEHICLE APPLICATION
 FL6

Cylinder Bore	Ø92.00	Number of Cylinders	1	Water or Air Cooled	Water	Unloader Port Size	-
Stroke	54 mm	Air Inlet Port Size	M26x1,5	Through Drive	Gear	Water Inlet Port Size	M16x1,5
Swept Volume	360 cm ³	Air Delivery Port Size	M18x1,5	With ESS System	-	Water Delivery Port Size	M16x1,5

Complete Cylinderhead

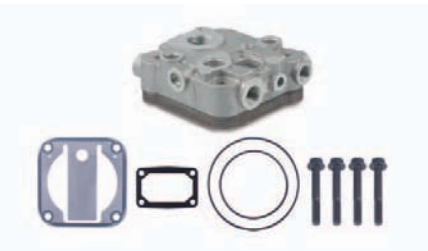
CK.185.100

Cylinderhead

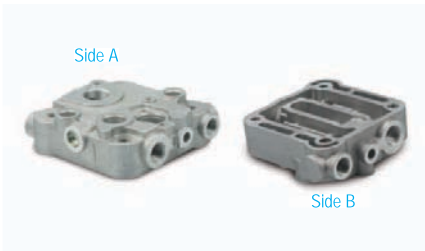
CK.185.1010

Complete Valve Plate

CK.185.200



Valve Plate

CK.185.2010

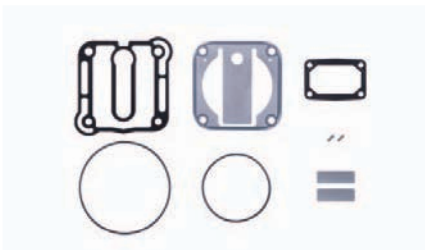
Repair Kit

CK.185.903

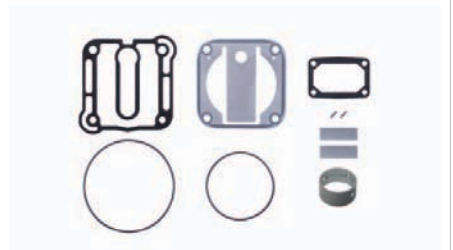
Repair Kit

CK.185.904





Piston & Ring 92.00 mm CK.173.350

2.50+2.50+4.00

92.25 mm CK.173.960

92.50 mm CK.173.970



KNORR-BREMSE : SEB22530 / K012079

Piston 92.00 mm CK.173.351

92.25 mm CK.173.961

92.50 mm CK.173.971



Ring 92.00 mm CK.165.352

2.50+2.50+4.00

92.25 mm CK.165.962

92.50 mm CK.165.972



Crankcase **CK.185.400**



Connecting Rod **CK.108.500**



VOLVO : 3090386 / 1698528 / 1697281
KNORR-BREMSE : SEB00626004 / SEB00957004

Crankshaft **CK.185.601**



Bushing **CK.116.434**

42x38x25



VOLVO : 1697278 / 1697286
KNORR-BREMSE : EB00819

Rear Cover **CK.116.720**

Aluminum Bushing Cover



VOLVO : 3097150
KNORR-BREMSE : II159920065

Gasket Kit **CK.185.905**



VOLVO : 85104328

Valve Kit **CK.185.906**



Repair Kit **CK.185.911**

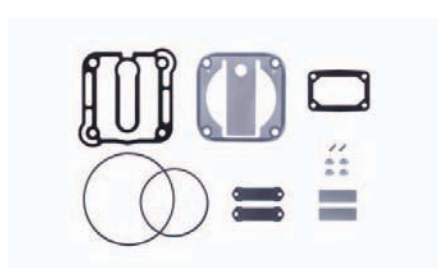

Nut **MC202061FX**

M20x1.5 Right Hand



VOLVO : 1698672

CK.195.000

 VOLVO
 20429337
 3987601
 8113263
 85000063
 KNORR-BREMSE
 LK3982
 K000274000

CK.205.000

 VOLVO
 1628592
 8112583
 KNORR-BREMSE
 LK3930
 II18606

VEHICLE APPLICATION
 FH12 / FH16 / F16

Cylinder Bore	Ø88.00	Number of Cylinders	1	Water or Air Cooled	Water	Unloader Port Size	M22x1,5
Stroke	50 mm	Air Inlet Port Size	Ø29	Through Drive	Gear	Water Inlet Port Size	M16x1,5
Swept Volume	300 cm ³	Air Delivery Port Size	M26x1,5	With ESS System	Yes	Water Delivery Port Size	M16x1,5

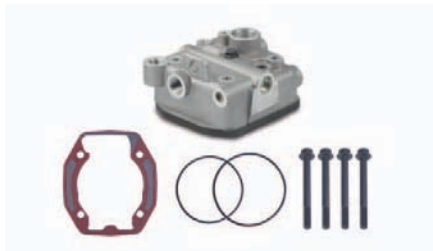
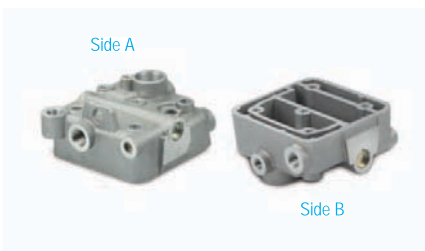
 Complete Cylinderhead **CK.195.100**

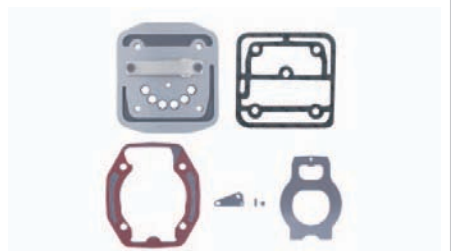
 Cylinderhead **CK.195.1010**

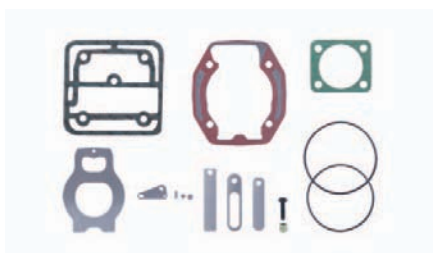
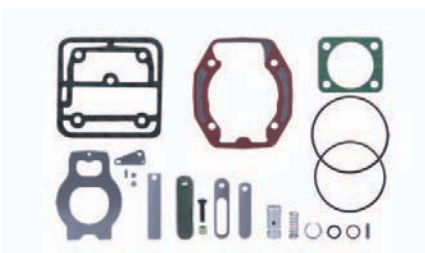
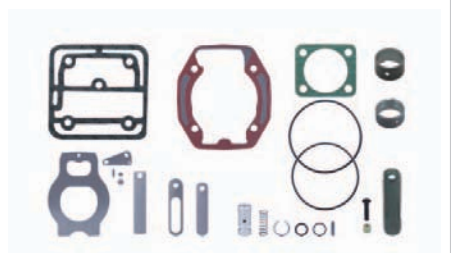
 VOLVO : 1699823
 KNORR-BREMSE : II162440061

 Complete Valve Plate **CK.195.200**

 VOLVO : 1699825
 KNORR-BREMSE : II14777004

 Repair Kit **CK.195.912**

 Repair Kit **CK.195.903**

 Repair Kit **CK.195.904**



Piston & Ring 88.00 mm CK.116.350

88.25 mm CK.116.960

88.50 mm CK.116.970

KNORR-BREMSE : SEB22555

Piston 88.00 mm CK.116.351

88.25 mm CK.116.961

88.50 mm CK.116.971

Ring 88.00 mm CW.116.352

2.00+2.00+4.00

88.25 mm CW.116.962

88.50 mm CW.116.972

Crankcase CK.195.400

KNORR-BREMSE : I80411

Connecting Rod CK.102.500

VOLVO : 1698852
KNORR-BREMSE : B80110 / I60599

Crankshaft CK.195.601

KNORR-BREMSE : I85022

Cylinder Liner & Piston CK.137.300

STD. Piston & Ring

KNORR-BREMSE : I808640061

Cylinder Liner CK.137.3010

KNORR-BREMSE : K000998

Flange Cover CK.195.700

KNORR-BREMSE : I114864

Bushing CK.102.708

34x30x16

KNORR-BREMSE : B64572

Bushing CK.102.434

34x30x16

KNORR-BREMSE : B44935

Repair Kit CK.195.905

VOLVO : 1699822
KNORR-BREMSE : I1147860051

CK.203.000

 VOLVO
 20429341
 8113406
 8122459

 KNORR-BREMSE
 LK3986
 K000275000

VEHICLE APPLICATION

 FH12 / FH16
 FM12
 F16

Cylinder Bore	Ø88.00	Number of Cylinders	1	Water or Air Cooled	Water	Unloader Port Size	-
Stroke	50 mm	Air Inlet Port Size	Ø29	Through Drive	Gear	Water Inlet Port Size	M16x1,5
Swept Volume	300 cm ³	Air Delivery Port Size	M26x1,5	With ESS System	No	Water Delivery Port Size	M16x1,5

Complete Cylinderhead

CK.203.100

Cylinderhead

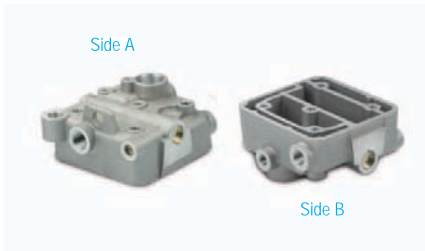
CK.203.1010

Complete Valve Plate

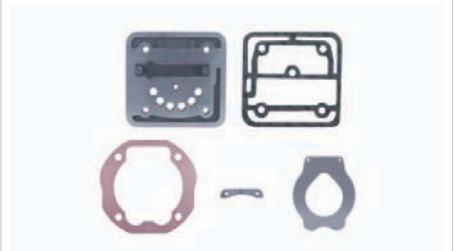
CK.203.200

VOLVO

: 3099753

Repair Kit

CK.203.910

Repair Kit

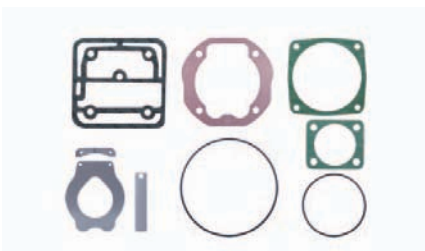
CK.203.903

Repair Kit

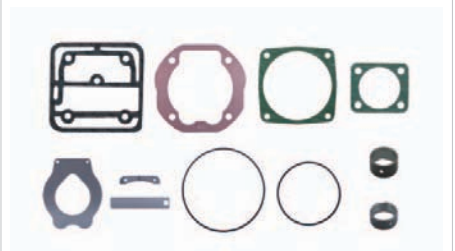
CK.203.904

VOLVO

: 3099754



Piston & Ring 88.00 mm CK.116.350

88.25 mm CK.116.960

88.50 mm CK.116.970

KNORR-BREMSE : SEB22555

Piston 88.00 mm CK.116.351

88.25 mm CK.116.961

88.50 mm CK.116.971

Ring 88.00 mm CW.116.352

2.00+2.00+4.00

88.25 mm CW.116.962

88.50 mm CW.116.972

Crankcase CK.195.400

KNORR-BREMSE : I80411

Connecting Rod CK.102.500

VOLVO : 1698852

KNORR-BREMSE : B80110 / I60599

Crankshaft CK.195.601

KNORR-BREMSE : I85022

Cylinder Liner & Piston CK.105.300

STD. Piston & Ring

Cylinder Liner CK.105.3010

Flange Cover CK.195.700

KNORR-BREMSE : I114864

Bushing CK.102.708

34x30x16

KNORR-BREMSE : B64572

Bushing CK.102.434

34x30x16

KNORR-BREMSE : B44935

Repair Kit CK.203.905

KNORR-BREMSE : I11377570051

CK.208.000

 VOLVO
 20442353
 8157550
 8112851
 85000065

 KNORR-BREMSE
 LP4960

VEHICLE APPLICATION
 FL12

Cylinder Bore	Ø88.00	Number of Cylinders	2	Water or Air Cooled	Water	Unloader Port Size	M22x1,5
Stroke	50 mm	Air Inlet Port Size	Ø29	Through Drive	Gear	Water Inlet Port Size	M16x1,5
Swept Volume	608 cm ³	Air Delivery Port Size	M26x1,5	With ESS System	Yes	Water Delivery Port Size	M16x1,5

Complete Cylinderhead

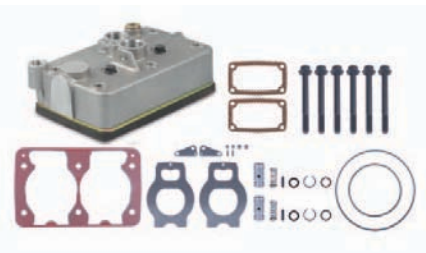
CK.116.1000

Cylinderhead

CK.116.1010

FIT LP4934 / LP4949 / LP4960 / LP4967 / LP4968

 VOLVO : 3097144
 KNORR-BREMSE : SEB01052004

Complete Valve Plate

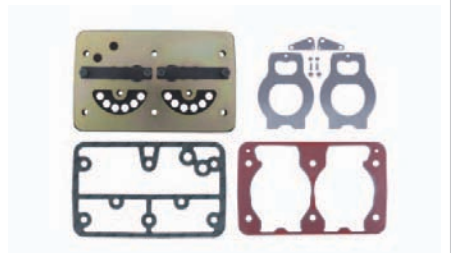
CK.116.200

 VOLVO : 3097146
 KNORR-BREMSE : SEB01033004

Valve Plate

CK.116.2010

Repair Kit

CK.116.903

Repair Kit

CK.116.905



Piston & Ring 88.00 mm CK.116.350

2.50+2.50+4.00

88.25 mm CK.116.960

88.50 mm CK.116.970

VOLVO : 85101375 / 3095841 / 1698848
 KNORR-BREMSE : SEB22555

Piston 88.00 mm CK.116.351

88.25 mm CK.116.961

88.50 mm CK.116.971

Ring 88.00 mm CK.116.352

2.50+2.50+4.00

88.25 mm CK.116.962

88.50 mm CK.116.972

VOLVO : 85100626 / 3097153
 KNORR-BREMSE : II39526F0061

Crankcase CK.117.400

Connecting Rod CK.116.500

VOLVO : 3097151
 KNORR-BREMSE : SEB00967004

Crankshaft CK.117.601

Bushing CK.116.434

42x38x25

VOLVO : 1697278 / 1697286
 KNORR-BREMSE : EB00819

Rear Cover CK.116.720

Aluminum Bushing Cover

VOLVO : 3097150
 KNORR-BREMSE : II159920065

Valve Kit CK.116.907

VOLVO : 3091739
 KNORR-BREMSE : II326840061

Valve Kit CK.116.908

VOLVO : 3091718
 KNORR-BREMSE : SEB01138004 / SEB011380061

Repair Kit CK.116.912

Repair Kit CK.116.921

VOLVO : 3097147
 KNORR-BREMSE : II159920063

CK.233.000

 VOLVO
 20568592
 85000344
 3181132
 8113829
 85000433

 KNORR-BREMSE
 LK3841

VEHICLE APPLICATION
 FL6



Cylinder Bore	Ø80.00	Number of Cylinders	1	Water or Air Cooled	Water	Unloader Port Size	-
Stroke	45 mm	Air Inlet Port Size	M26x1,5	Through Drive	Gear	Water Inlet Port Size	M16x1,5
Swept Volume	225 cm ³	Air Delivery Port Size	M18x1,5	With ESS System	-	Water Delivery Port Size	M16x1,5

Complete Cylinderhead

CK.233.100

KNORR-BREMSE : K034890K50

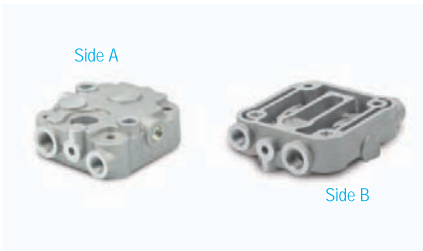
Cylinderhead

CK.233.1010

Complete Valve Plate

CK.233.200

KNORR-BREMSE : SEB01916004

Valve Plate

CK.233.2010

Repair Kit

CK.233.901

Repair Kit

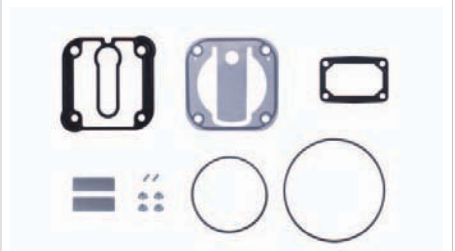
CK.233.903





Piston & Ring 80.00 mm CN.127.350

2.50+2.50+4.00

80.25 mm CN.127.960

80.50 mm CN.127.970



KNORR-BREMSE : SEB22517

Piston 80.00 mm CN.127.351

80.25 mm CN.127.961

80.50 mm CN.127.971



Ring 80.00 mm CN.127.352

2.50+2.50+4.00

80.25 mm CN.127.962

80.50 mm CN.127.972



Crankcase **CK.233.400**



Connecting Rod **CK.107.500**



VOLVO : 1697281 / 1698528 / 3090386
KNORR-BREMSE : SEB00626004 / SEB00957004

Crankshaft **CK.234.601**



Bushing **CK.116.434**

42x38x25



VOLVO : 1697278 / 1697286
KNORR-BREMSE : EB00819

Crankshaft Nut **MC202061FX**

M20x1.5 Right Hand Thread



VOLVO : 1698672

Rear Cover **CK.116.720**

Aluminum Bushing Cover



VOLVO : 3097150
KNORR-BREMSE : I1159920065

Repair Kit **CK.233.904**



Repair Kit **CK.233.911**

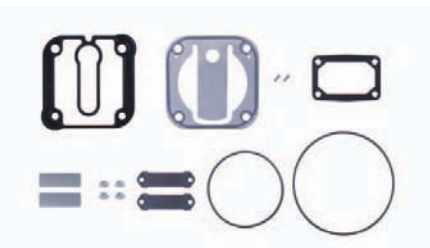

Repair Kit **CK.233.913**



KNORR-BREMSE : SEB22518

CV.101.000

 VOLVO
 3038304

 VARGA
 RCCS00229
 EL1600

VEHICLE APPLICATION

 NL10 / NL12
 N10 / N12
 B10M / B58



Cylinder Bore	Ø69.85 mm	Number of Cylinders	2	Water or Air Cooled	Water	Unloader Port Size	1/8" NPT
Stroke	47.50 mm	Air Inlet Port Size	-	Through Drive	-	Water Inlet Port Size	1/2" NPT
Swept Volume	360 cm ³	Air Delivery Port Size	Ø22.50 mm	With ESS System	Yes	Water Delivery Port Size	1/2" NPT

Complete Cylinderhead

CV.101.100

VARGA : RCCG 0003.2

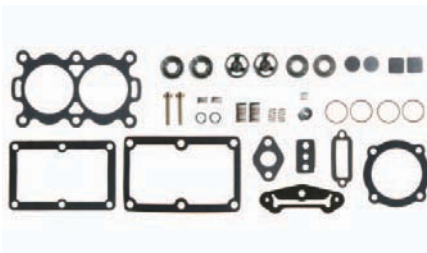
Repair Kit

CV.101.903

Repair Kit

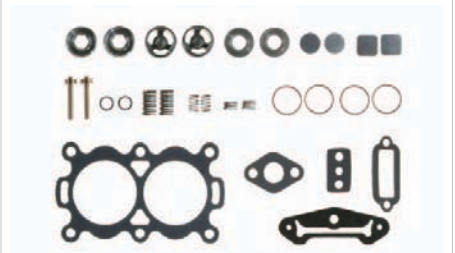
CV.101.910

VARGA : RRCG 0010.1

Repair Kit

CV.101.906

Repair Kit

CV.101.912

Repair Kit

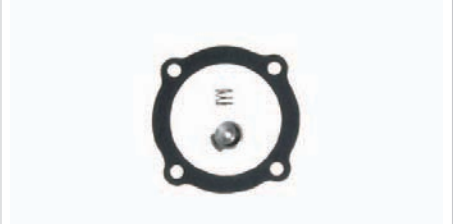
CV.101.915



Piston & Ring

69.85 mm CV.101.350

70.10 mm CV.101.960

70.35 mm CV.101.970

VARGA :RREB 0010.6 STD

Piston

69.85 mm CV.101.351

70.10 mm CV.101.961

70.35 mm CV.101.971

Ring

69.85 mm CV.101.352

70.10 mm CV.101.962

70.35 mm CV.101.972

VARGA :RRAN 0001.6 STD

Crankcase

CV.101.400

VARGA :RPCY 0006.2

Connecting Rod

CV.101.500

VARGA :RPBI 0001.9

Connecting Rod Bearing

CV.101.507

VARGA :RRCQ 004.1 STD

Crankshaft

CV.101.601

VARGA :RPVI 0016.1

Cylinder Liner

CV.101.3010

VARGA :RPBL 0008.2

Ball Bearing

6207

VARGA :RPBI 0001.2

Unloader Cover

CV.101.050

Rear Cover

CV.101.720

VARGA :RRTP 0014.4

Sump Cover

CV.101.751

CW.107.000

VOLVO
 1626060
 5003460
 WABCO
 911 505 150 0

VEHICLE APPLICATION

F10 / F12 / F16
 FL10 / FL7
 NL12
 FM10



Cylinder Bore	Ø85.00	Number of Cylinders	2	Water or Air Cooled	Water	Unloader Port Size	-
Stroke	62 mm	Air Inlet Port Size	Ø35	Through Drive	Gear	Water Inlet Port Size	M16x1,5
Swept Volume	704 cm ³	Air Delivery Port Size	M26x1,5	With ESS System	-	Water Delivery Port Size	M16x1,5

Complete Cylinderhead

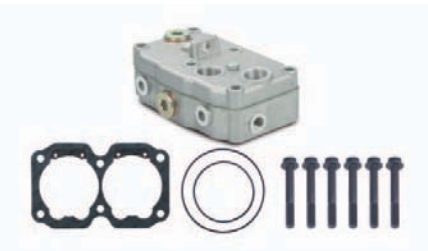
CW.107.100

VOLVO : 3094622
 WABCO : 911 505 804 2

Cylinder Up Head

CW.107.1020



Cylinder Bottom Head

CW.107.1040

Repair Kit

CW.107.903

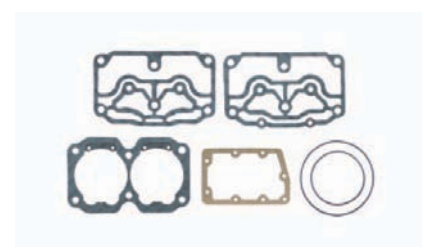
Gasket Kit

CW.107.905

Valve Kit

CW.107.906

VOLVO : 85104629
 WABCO : 911 505 001 2



Piston & Ring 85.00 mm CW.107.350

85.25 mm CW.107.960

85.50 mm CW.107.970

VOLVO : 1698686
WABCO : 911 501 624 2 / 911 501 625 2

Piston 85.00 mm CW.107.351

85.25 mm CW.107.961

85.50 mm CW.107.971

Ring 85.00 mm CW.109.352

2.00+2.00+4.00

85.25 mm CW.109.962

85.50 mm CW.109.972

VOLVO : 3094621
WABCO : 911 501 920 2

Crankcase **CW.107.400**

Connecting Rod **CW.107.500**

VOLVO : 1698678
WABCO : 911 505 732 2

Crankshaft **CW.107.601**

VOLVO : 1698670
WABCO : 911 505 691 4

Ball Bearing **6307**

VOLVO : 1698671
WABCO : 895 251 02 02

Crankshaft Nut **MC202061FX**

M20x1.5 Right Hand Thread

VOLVO : 1698672

Rear Cover **CW.107.720**

VOLVO : 3094836
WABCO : 911 505 664 4

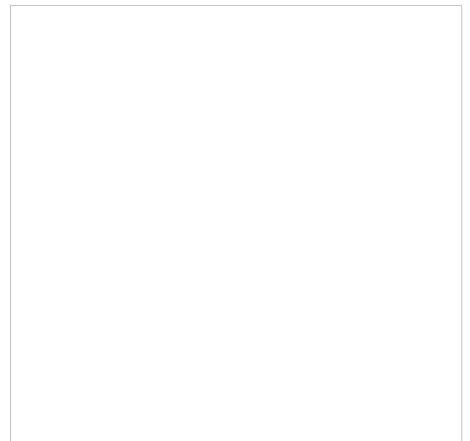
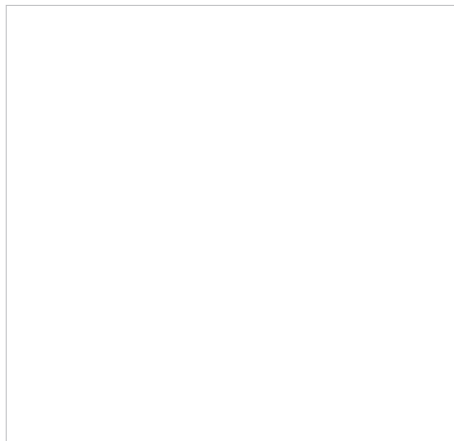
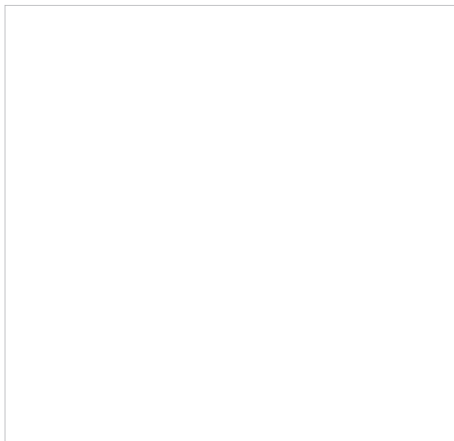

CW.118.000

 VOLVO
 20382348
 21353460

 WABCO
 412 352 005 0
 412 352 030 0

VEHICLE APPLICATION

 FH12
 FM12
 NH12

Cylinder Bore	Ø85.00	Number of Cylinders	1	Water or Air Cooled	Water	Unloader Port Size	M12x1,5
Stroke	62 mm	Air Inlet Port Size	Ø35	Through Drive	Gear	Water Inlet Port Size	M16x1,5
Swept Volume	352 cm ³	Air Delivery Port Size	M26x1,5	With ESS System	Yes	Water Delivery Port Size	M16x1,5

Complete Cylinderhead

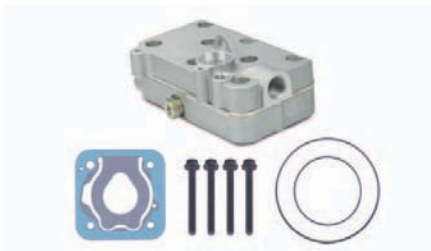
CW.118.100

 VOLVO : 85104246
 WABCO : 412 352 921 2

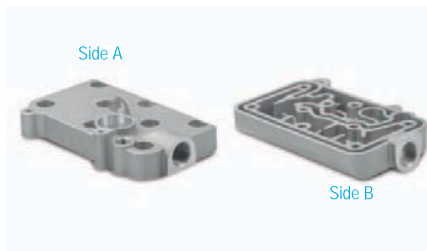
Cylinder Up head

CW.118.1020

Cooling Plate

CW.118.238

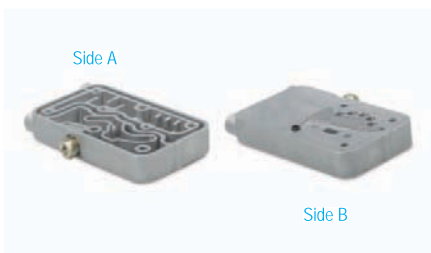

Cylinder Bottom Head

CW.118.1040

Repair Kit

CW.118.901

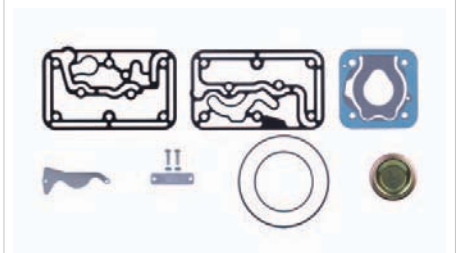
Repair Kit

CW.118.903



Piston & Ring 85.00 mm CW.109.350

85.25 mm CW.109.960

85.50 mm CW.109.970

VOLVO : 1698686
WABCO : 911 501 624 2 / 911 501 625 2

Piston 85.00 mm CW.109.351

85.25 mm CW.109.961

85.50 mm CW.109.971

Ring 85.00 mm CW.109.352

2.00+2.00+4.00

85.25 mm CW.109.962

85.50 mm CW.109.972

VOLVO : 3094621
WABCO : 911 501 920 2

Crankcase CW.118.400

WABCO : 412 352 012 6

Connecting Rod CW.107.500

VOLVO : 1698678
WABCO : 911 505 732 2

Crankshaft CW.118.601

WABCO : 412 352 691 4

Bushing CW.101.434

39x35x20

Crankshaft Nut MC202061FX

M20x1.5 Right Hand Thread

VOLVO : 1698672

Rear Cover CW.118.720

Aluminum Bushing Cover

Repair Kit CW.118.904

Gasket Kit CW.118.913

VOLVO : 85102273
WABCO : 412 352 003 2

Sump Cover CW.123.751

VOLVO : 3094835
WABCO : 895 073 589 4

CW.142.000

 VOLVO
 20701801
 20382347
 20547525
 85000396
 20569224

 WABCO
 412 704 008 0
 412 704 001 0
 412 704 004 0
 412 704 005 0

VEHICLE APPLICATION

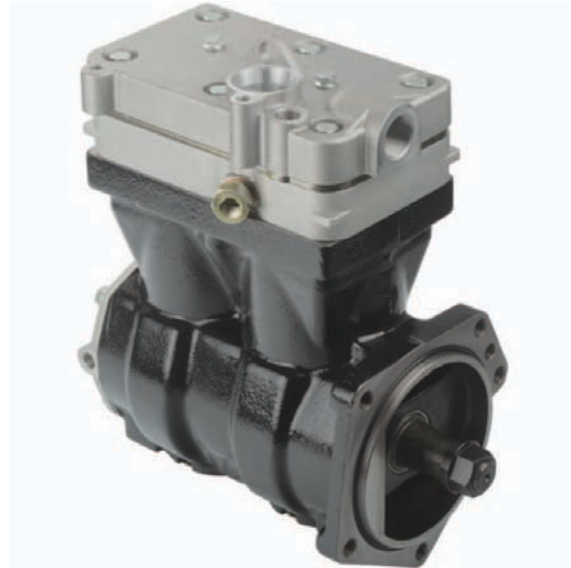
 FH12
 FM12
 NH12

Cylinder Bore	Ø85.00	Number of Cylinders	2	Water or Air Cooled	Water	Unloader Port Size	M12x1
Stroke	62 mm	Air Inlet Port Size	Ø35	Through Drive	Gear	Water Inlet Port Size	M16x1,5
Swept Volume	704 cm ³	Air Delivery Port Size	M26x1,5	With ESS System	Yes	Water Delivery Port Size	M16x1,5

Complete Cylinderhead

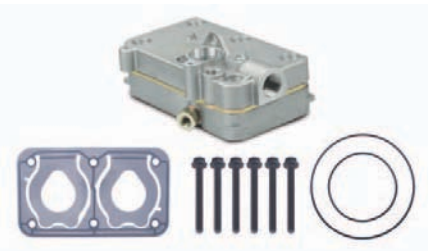
CW.142.100

 VOLVO : 20701803
 WABCO : 412 704 932 2

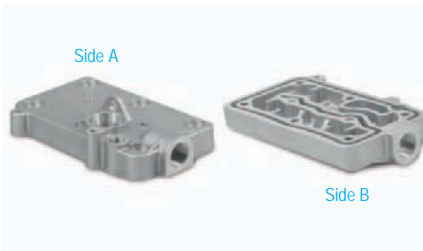
Cylinder Up head

CW.142.1020

Cooling Plate

CW.142.238



Cylinder Bottom Head

CW.142.1040

Repair Kit

CW.142.901

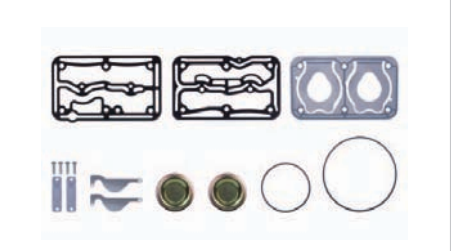
Repair Kit

CW.142.903



Piston & Ring 85.00 mm CW.109.350

85.25 mm CW.109.960

85.50 mm CW.109.970

VOLVO : 1698686
WABCO : 911 501 624 2 / 911 501 625 2

Piston 85.00 mm CW.109.351

85.25 mm CW.109.961

85.50 mm CW.109.971

Ring 85.00 mm CW.109.352

2.00+2.00+4.00

85.25 mm CW.109.962

85.50 mm CW.109.972

VOLVO : 3094621
WABCO : 911 501 920 2

Crankcase CW.142.400

Connecting Rod CW.107.500

VOLVO : 1698678
WABCO : 911 505 732 2

Crankshaft CW.142.601

Bushing CW.142.434

WABCO : 411 522 340 4

Crankshaft Nut MC202061FX

M20x1.5 Right Hand Thread

VOLVO : 1698672

Rear Cover CW.142.720

Aluminum Bushing Cover

Repair Kit CW.142.904

Repair Kit CW.142.913

Sump Cover CW.123.751

VOLVO : 3094835
WABCO : 895 073 589 4

CW.158.000

 VOLVO
 20382346
 20478166
 21353457

 WABCO
 412 352 004 0
 412 352 029 0

VEHICLE APPLICATION

 FH12
 FM9
 FM12
 NH12

Cylinder Bore	Ø85.00	Number of Cylinders	1	Water or Air Cooled	Water	Unloader Port Size	M12x1,5
Stroke	62 mm	Air Inlet Port Size	Ø35	Through Drive	Gear	Water Inlet Port Size	M16x1,5
Swept Volume	352 cm ³	Air Delivery Port Size	M26x1,5	With ESS System	Yes	Water Delivery Port Size	M16x1,5

Complete Cylinderhead

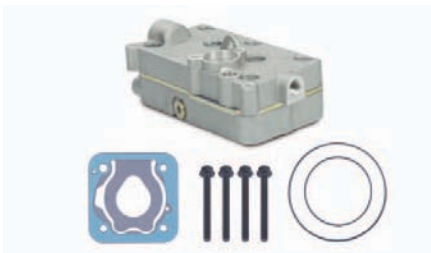
CW.208.100

 VOLVO : 85104248
 WABCO : 412 352 920 2

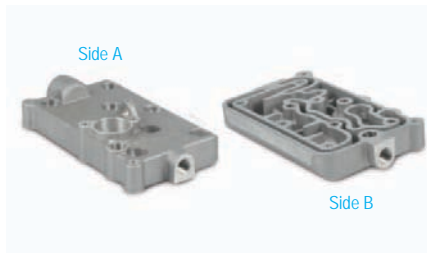
Cylinder Up head

CW.208.1020

Cooling Plate

CW.208.238



Cylinder Bottom Head

CW.208.1040

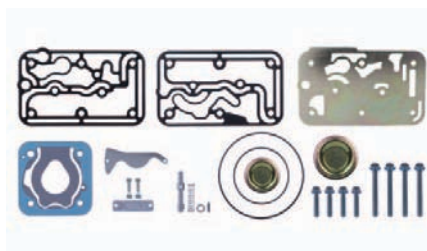
Repair Kit

CW.208.901

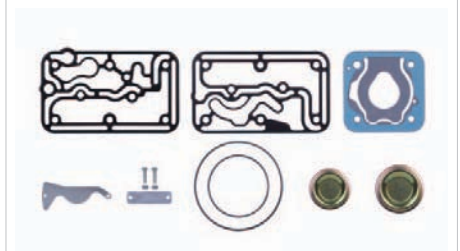
Repair Kit

CW.208.903

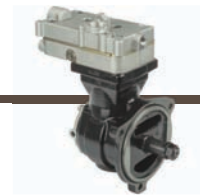

Piston & Ring 85.00 mm CW.109.350

85.25 mm CW.109.960

85.50 mm CW.109.970

VOLVO : 1698686
WABCO : 911 501 624 2 / 911 501 625 2

Piston 85.00 mm CW.109.351

85.25 mm CW.109.961

85.50 mm CW.109.971

Ring 85.00 mm CW.109.352

2.00+2.00+4.00

85.25 mm CW.109.962

85.50 mm CW.109.972

VOLVO : 3094621
WABCO : 911 501 920 2

Crankcase CW.158.400

Connecting Rod CW.107.500

VOLVO : 1698678
WABCO : 911 505 732 2

Crankshaft CW.158.601

Bushing CW.101.434

39x35x20

Crankshaft Nut MC202061FX

M20x1.5 Right Hand Thread

VOLVO : 1698672

Rear Cover CW.118.720

Aluminum Bushing Cover

Repair Kit CW.208.904

Gasket Kit CW.208.913

VOLVO : 85103938
WABCO : 412 352 004 2

Sump Cover CW.123.751

VOLVO : 3094835
WABCO : 895 073 589 4

CW.184.000

 VOLVO
 20775224
 85000491

 WABCO
 412 704 013 0

VEHICLE APPLICATION

 B9R
 B9L
 B9S
 B9TL

Cylinder Bore	Ø85.00	Number of Cylinders	2	Water or Air Cooled	Water	Unloader Port Size	M12x1,5
Stroke	62 mm	Air Inlet Port Size	Ø35	Through Drive	Gear	Water Inlet Port Size	M16x1,5
Swept Volume	704 cm ³	Air Delivery Port Size	M26x1,5	With ESS System	Yes	Water Delivery Port Size	M16x1,5

Complete Cylinderhead

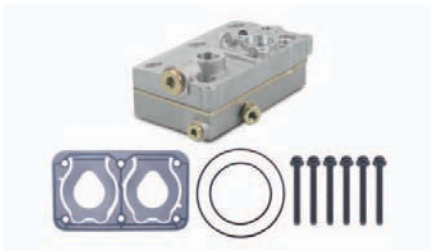
CW.184.100

 VOLVO : 20775236
 WABCO : 412 704 934 2

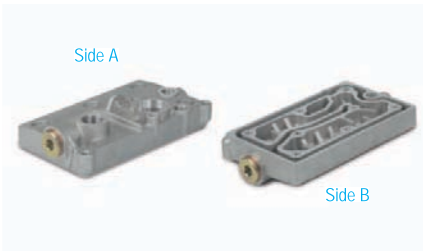
Cylinder Up head

CW.184.1020

Cooling Plate

CW.184.238

Cylinder Bottom Head

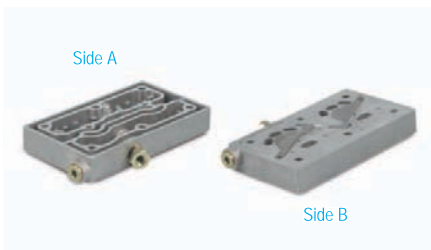
CW.184.1040

Repair Kit

CW.184.901

Repair Kit

CW.184.903



Piston & Ring 85.00 mm CW.109.350

85.25 mm CW.109.960

85.50 mm CW.109.970



VOLVO : 1698686
WABCO : 911 501 624 2 / 911 501 625 2

Piston 85.00 mm CW.109.351

85.25 mm CW.109.961

85.50 mm CW.109.971



Ring 85.00 mm CW.109.352

2.00+2.00+4.00

85.25 mm CW.109.962

85.50 mm CW.109.972



VOLVO : 3094621
WABCO : 911 501 920 2

Crankcase **CW.184.400**



Connecting Rod **CW.107.500**



VOLVO : 1698678
WABCO : 911 505 732 2

Crankshaft **CW.189.601**



WABCO : 412 704 691 4

Bushing **CW.142.434**



WABCO : 411 522 340 4

Crankshaft Nut **MC202061FX**

M20x1.5 Right Hand Thread



VOLVO : 1698672

Rear Cover **CW.142.720**

Aluminum Bushing Cover



Repair Kit **CW.184.904**



Repair Kit **CW.184.913**



WABCO : 412 704 939 2

Sump Cover **CW.123.751**



VOLVO : 3094835
WABCO : 895 073 589 4

CW.189.000

 VOLVO
 20845313
 20850846
 20765890

 WABCO
 412 704 015 0
 412 704 012 0

VEHICLE APPLICATION

 FH12 / FH16 / FH13
 FM12 / FM9
 NH12

Cylinder Bore	Ø85.00	Number of Cylinders	2	Water or Air Cooled	Water	Unloader Port Size	M16x1,5
Stroke	62 mm	Air Inlet Port Size	Ø35	Through Drive	Gear	Water Inlet Port Size	M16x1,5
Swept Volume	704 cm ³	Air Delivery Port Size	M26x1,5	With ESS System	Yes	Water Delivery Port Size	M16x1,5

Complete Cylinderhead

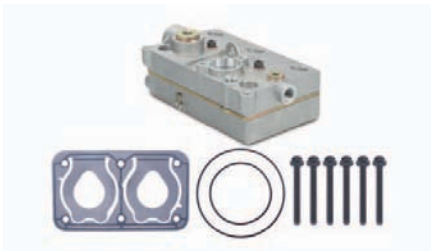
CW.189.100

 VOLVO : 20845004
 WABCO : 412 704 933 2

Cylinder Up head

CW.189.1020

Cooling Plate

CW.189.238



Cylinder Bottom Head

CW.189.1040

Repair Kit

CW.189.901

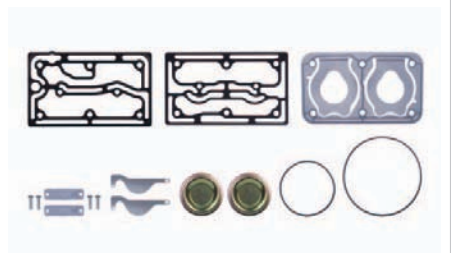
Repair Kit

CW.189.903



Piston & Ring 85.00 mm CW.109.350

85.25 mm CW.109.960

85.50 mm CW.109.970



VOLVO : 1698686
WABCO : 911 501 624 2 / 911 501 625 2

Piston 85.00 mm CW.109.351

85.25 mm CW.109.961

85.50 mm CW.109.971



Ring 85.00 mm CW.109.352

2.00+2.00+4.00

85.25 mm CW.109.962

85.50 mm CW.109.972



VOLVO : 3094621
WABCO : 911 501 920 2

Crankcase CW.189.400



Connecting Rod CW.107.500



VOLVO : 1698678
WABCO : 911 505 732 2

Crankshaft CW.189.601



WABCO : 412 704 691 4

Bushing CW.142.434



WABCO : 411 522 340 4

Crankshaft Nut MC202061FX

M20x1.5 Right Hand Thread



VOLVO : 1698672

Rear Cover CW.142.720

Aluminum Bushing Cover



Repair Kit CW.189.904



Repair Kit CW.189.913



WABCO : 412 704 939 2

Sump Cover CW.123.751



VOLVO : 3094835
WABCO : 895 073 589 4

CW.190.000

 VOLVO
 20774294
 WABCO
 912 512 004 0

CW.201.000

 VOLVO
 20846000
 22016995
 WABCO
 912 512 008 0
 912 512 029 0

VEHICLE APPLICATION

 FH12 / FH13 / FH16
 FM9 / FM12 / FM13
 B13R

Cylinder Bore	Ø85.00	Number of Cylinders	2	Water or Air Cooled	Water	Unloader Port Size	M16x1,5
Stroke	56 mm	Air Inlet Port Size	Ø35	Through Drive	Gear	Water Inlet Port Size	M16x1,5
Swept Volume	636 cm ³	Air Delivery Port Size	M26x1,5	With ESS System	Yes	Water Delivery Port Size	M16x1,5

Complete Cylinderhead

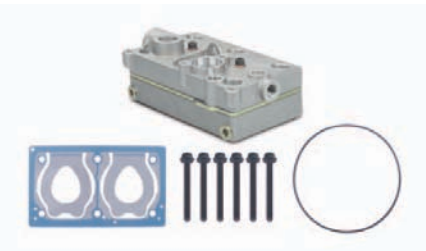
CW.190.100

 VOLVO : 20775236
 WABCO : 412 704 934 2

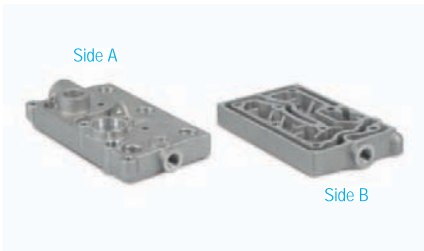
Cylinder Up head

CW.190.1020

Cooling Plate

CW.190.238

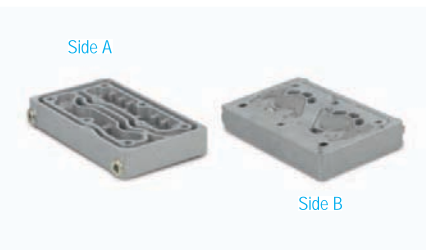

Cylinder Bottom Head

CW.190.1040

Repair Kit

CW.190.901

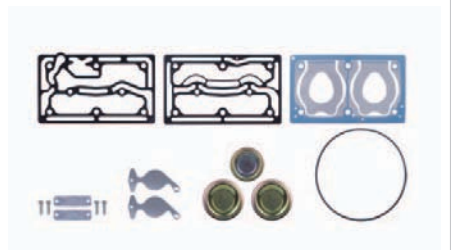
Repair Kit

CW.190.903



Piston & Ring 85.00 mm CW.109.350

85.25 mm CW.109.960

85.50 mm CW.109.970



VOLVO : 1698686
WABCO : 911 501 624 2 / 911 501 625 2

Piston 85.00 mm CW.109.351

85.25 mm CW.109.961

85.50 mm CW.109.971



Ring 85.00 mm CW.109.352

2.00+2.00+4.00

85.25 mm CW.109.962

85.50 mm CW.109.972



VOLVO : 3094621
WABCO : 911 501 920 2

Crankcase **CW.193.400**



Connecting Rod **CW.109.500**



WABCO : 911 145 737 2

Crankshaft **CW.193.601**



WABCO : 912 512 930 2 / 912 512 693 4

Bushing **CW.109.727**

52x48x19



Crankshaft Nut **MC202061FX**

M20x1.5 Right Hand Thread



VOLVO : 1698672

Rear Cover **CW.193.619**



WABCO : 912 000 340 4

Repair Kit **CW.190.912**



VOLVO : 21322318 / 21477052
WABCO : 912 512 927 2 / 412 704 938 2

Repair Kit **CW.190.913**



WABCO : 912 512 928 2

Sump Cover **CW.123.751**



VOLVO : 3094835
WABCO : 895 073 589 4

CW.199.000

 VOLVO
 20866605
 20574763

 WABCO
 412 704 016 0

VEHICLE APPLICATION

 B9R
 B9L
 B9S
 B9TL

Cylinder Bore	Ø85.00	Number of Cylinders	2	Water or Air Cooled	Water	Unloader Port Size	M12x1,5
Stroke	62 mm	Air Inlet Port Size	Ø35	Through Drive	Gear	Water Inlet Port Size	M16x1,5
Swept Volume	704 cm ³	Air Delivery Port Size	M26x1,5	With ESS System	Yes	Water Delivery Port Size	M16x1,5

Complete Cylinderhead

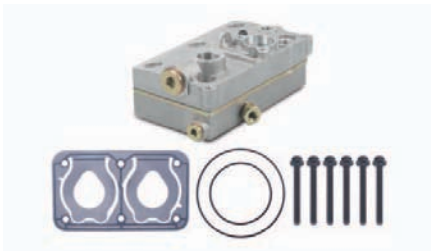
CW.184.100

 VOLVO : 20775236
 WABCO : 412 704 934 2

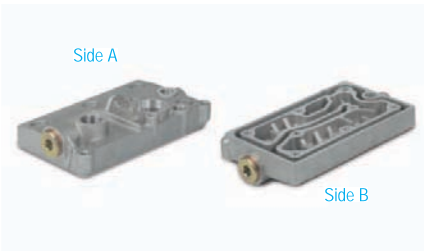
Cylinder Up head

CW.184.1020

Cooling Plate

CW.184.238

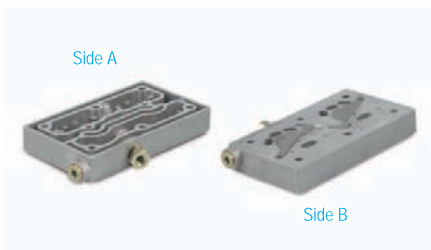

Cylinder Bottom Head

CW.184.1040

Repair Kit

CW.184.901

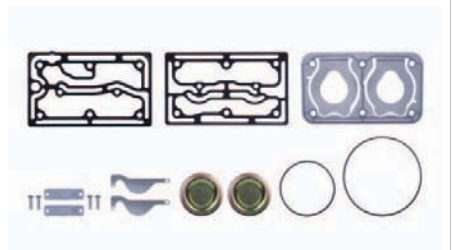
Repair Kit

CW.184.903

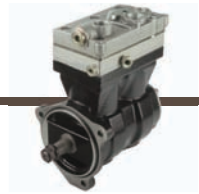

Piston & Ring 85.00 mm CW.109.350

85.25 mm CW.109.960

85.50 mm CW.109.970



VOLVO : 1698686
WABCO : 911 501 624 2 / 911 501 625 2

Piston 85.00 mm CW.109.351

85.25 mm CW.109.961

85.50 mm CW.109.971



Ring 85.00 mm CW.109.352

2.00+2.00+4.00

85.25 mm CW.109.962

85.50 mm CW.109.972



VOLVO : 3094621
WABCO : 911 501 920 2

Crankcase CW.184.400



Connecting Rod CW.107.500



VOLVO : 1698678
WABCO : 412 704 691 4 / 412 704 941 2

Crankshaft CW.189.601



VOLVO : 3094621
WABCO : 911 501 920 2

Bushing CW.142.434



VOLVO : 1698672

Crankshaft Nut MC202061FX

M20x1.5 Right Hand Thread



Rear Cover CW.142.720

Aluminum Bushing Cover



Repair Kit CW.184.904



Repair Kit CW.184.913



VOLVO : 3094835
WABCO : 895 073 589 4

Sump Cover CW.123.751



VOLVO : 3094835
WABCO : 895 073 589 4

CW.200.000

 VOLVO
 21172036
 85003282
 21379906
 22040497

 WABCO
 412 704 018 0
 412 704 023 0
 412 704 027 0

VEHICLE APPLICATION

 FH12 / FH13 / FH16
 FM9 / FM12 / FM13
 B13R

Cylinder Bore	Ø85.00	Number of Cylinders	2	Water or Air Cooled	Water	Unloader Port Size	M16x1,5
Stroke	62 mm	Air Inlet Port Size	Ø35	Through Drive	Gear	Water Inlet Port Size	M16x1,5
Swept Volume	704 cm ³	Air Delivery Port Size	M26x1,5	With ESS System	Yes	Water Delivery Port Size	M16x1,5

Complete Cylinderhead

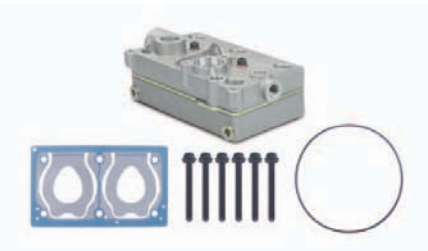
CW.190.100

 VOLVO : 20775236
 WABCO : 412 704 934 2

Cylinder Up head

CW.190.1020

Cooling Plate

CW.190.238

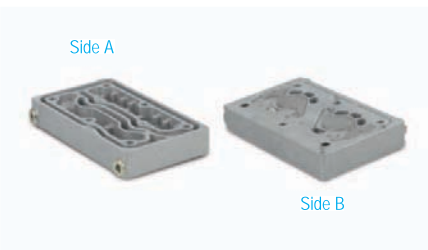

Cylinder Bottom Head

CW.190.1040

Repair Kit

CW.190.901

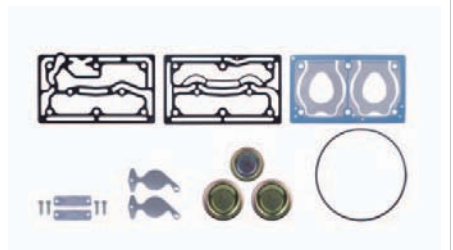
Repair Kit

CW.190.903



Piston & Ring 85.00 mm CW.109.350

85.25 mm CW.109.960

85.50 mm CW.109.970



VOLVO : 1698686
WABCO : 911 501 624 2 / 911 501 625 2

Piston 85.00 mm CW.109.351

85.25 mm CW.109.961

85.50 mm CW.109.971



Ring 85.00 mm CW.109.352

2.00+2.00+4.00

85.25 mm CW.109.962

85.50 mm CW.109.972



VOLVO : 3094621
WABCO : 911 501 920 2

Crankcase **CW.200.400**



Connecting Rod **CW.123.500**



WABCO : 911 145 738 2

Crankshaft **CW.200.601**



Bushing **CW.109.727**

52x48x19



Crankshaft Nut **MC202061FX**

M20x1.5 Right Hand Thread



VOLVO : 1698672

Rear Cover **CW.193.619**



WABCO : 912 000 340 4

Repair Kit **CW.190.912**



VOLVO : 21322318 / 21477052
WABCO : 912 512 927 2 / 412 704 938 2

Repair Kit **CW.190.913**



WABCO : 912 512 928 2

Sump Cover **CW.123.751**



VOLVO : 3094835
WABCO : 895 073 589 4

CW.202.000

VOLVO
20842990
20382345
20478151
20569928
20773343
85000614
85000360
85000487

WABCO
412 704 014 0
412 704 000 0
412 704 006 0
412 704 010 0

VEHICLE APPLICATION

FH12 / FH16 / FH13
FM12 / FM9
NH12



Cylinder Bore	Ø85.00	Number of Cylinders	2	Water or Air Cooled	Water	Unloader Port Size	M16x1,5
Stroke	62 mm	Air Inlet Port Size	Ø35	Through Drive	Gear	Water Inlet Port Size	M16x1,5
Swept Volume	704 cm ³	Air Delivery Port Size	M26x1,5	With ESS System	Yes	Water Delivery Port Size	M16x1,5

Complete Cylinderhead

CW.202.100

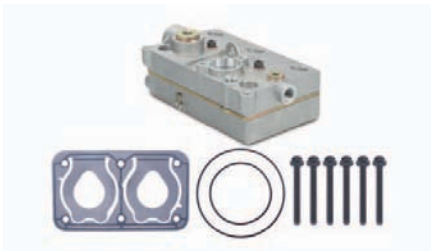

VOLVO : 20845004
WABCO : 412 704 933 2

Cylinder Up head

CW.189.1020



Cooling Plate

CW.189.238



Cylinder Bottom Head

CW.189.1040



Repair Kit

CW.202.901



Repair Kit

CW.202.903



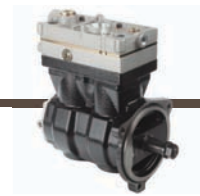

Piston & Ring 85.00 mm CW.109.350

85.25 mm CW.109.960

85.50 mm CW.109.970

VOLVO : 1698686
WABCO : 911 501 624 2 / 911 501 625 2

Piston 85.00 mm CW.109.351

85.25 mm CW.109.961

85.50 mm CW.109.971

Ring 85.00 mm CW.109.352

2.00+2.00+4.00

85.25 mm CW.109.962

85.50 mm CW.109.972

VOLVO : 3094621
WABCO : 911 501 920 2

Crankcase CW.202.400

Connecting Rod CW.107.500

VOLVO : 1698678
WABCO : 911 505 732 2

Crankshaft CW.189.601

WABCO : 412 704 691 4

Bushing CW.142.434

WABCO : 411 522 340 4

Crankshaft Nut MC202061FX

M20x1.5 Right Hand Thread

VOLVO : 1698672

Rear Cover CW.142.720

Aluminum Bushing Cover

Repair Kit CW.202.904

Repair Kit CW.202.913

WABCO : 412 704 939 2

Sump Cover CW.123.751

VOLVO : 3094835
WABCO : 895 073 589 4

CW.208.000

 VOLVO
 21353433
 20451727
 20733972

 WABCO
 912 112 000 0
 912 112 001 0
 912 114 000 0

VEHICLE APPLICATION

 FH12
 FM9
 FM12
 NH12

Cylinder Bore	Ø85.00	Number of Cylinders	1	Water or Air Cooled	Water	Unloader Port Size	M12x1,5
Stroke	62 mm	Air Inlet Port Size	Ø35	Through Drive	Gear	Water Inlet Port Size	M16x1,5
Swept Volume	352 cm ³	Air Delivery Port Size	M26x1,5	With ESS System	Yes	Water Delivery Port Size	M16x1,5

Complete Cylinderhead

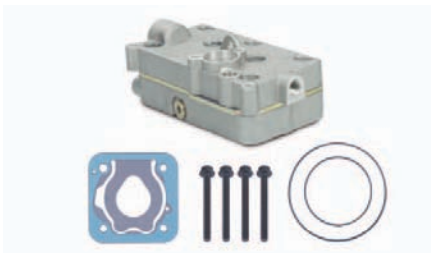
CW.208.100

 VOLVO : 85104248
 WABCO : 412 352 920 2

Cylinder Up head

CW.208.1020



Cooling Plate

CW.208.238

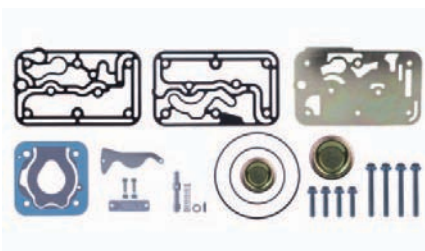

Cylinder Bottom Head

CW.208.1040

Repair Kit

CW.208.901

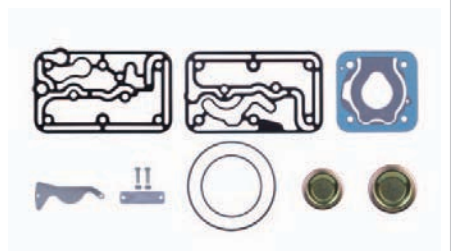
Repair Kit

CW.208.903



Piston & Ring 85.00 mm CW.109.350

85.25 mm CW.109.960

85.50 mm CW.109.970

VOLVO : 1698686
WABCO : 911 501 624 2 / 911 501 625 2

Piston 85.00 mm CW.109.351

85.25 mm CW.109.961

85.50 mm CW.109.971

Ring 85.00 mm CW.109.352

2.00+2.00+4.00

85.25 mm CW.109.962

85.50 mm CW.109.972

VOLVO : 3094621
WABCO : 911 501 920 2

Crankcase **CW.208.400**

Connecting Rod **CW.123.500**

WABCO : 911 145 737 2

Crankshaft **CW.208.601**

Bushing **CW.193.708**

Crankshaft Nut **MC202061FX**

M20x1.5 Right Hand Thread

VOLVO : 1698672

Bushing **CW.109.727**

52x48x19

Repair Kit **CW.208.904**

Gasket Kit **CW.208.913**

VOLVO : 85103938
WABCO : 412 352 004 2

Rear Cover **CW.153.721**

CW.223.000

 VOLVO
 20733974

 WABCO
 912 142 000 0

VEHICLE APPLICATION

 FH12
 FM9
 FM12
 NH12

Cylinder Bore	Ø85.00	Number of Cylinders	1	Water or Air Cooled	Water	Unloader Port Size	M12x1,5
Stroke	62 mm	Air Inlet Port Size	Ø35	Through Drive	Gear	Water Inlet Port Size	M16x1,5
Swept Volume	352 cm ³	Air Delivery Port Size	M26x1,5	With ESS System	Yes	Water Delivery Port Size	M16x1,5

Complete Cylinderhead

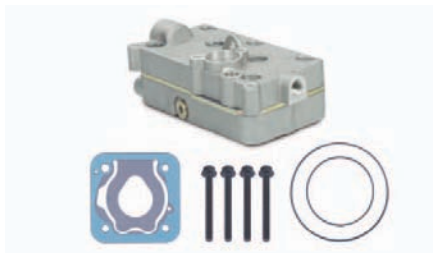
CW.208.100

 VOLVO : 85104248
 WABCO : 412 352 920 2

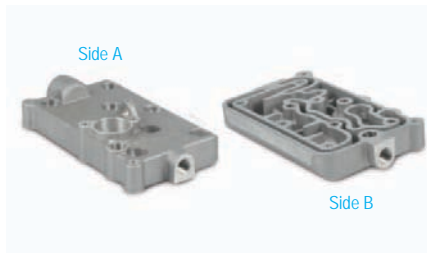
Cylinder Up head

CW.208.1020

Cooling Plate

CW.208.238



Cylinder Bottom Head

CW.208.1040

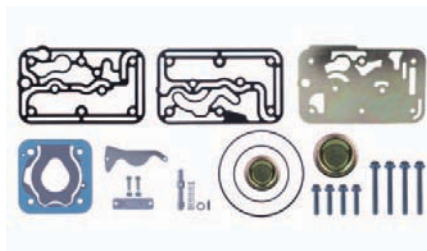
Repair Kit

CW.208.901

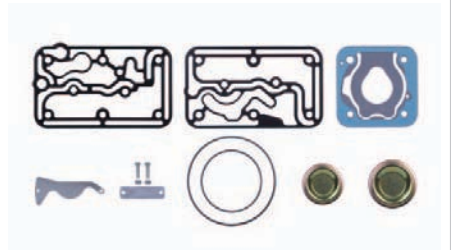
Repair Kit

CW.208.903



Piston & Ring 85.00 mm CW.109.350

85.25 mm CW.109.960

85.50 mm CW.109.970

VOLVO : 1698686
WABCO : 911 501 624 2 / 911 501 625 2

Piston 85.00 mm CW.109.351

85.25 mm CW.109.961

85.50 mm CW.109.971

Ring 85.00 mm CW.109.352

2.00+2.00+4.00

85.25 mm CW.109.962

85.50 mm CW.109.972

VOLVO : 3094621
WABCO : 911 501 920 2

Crankcase **CW.208.400**

Connecting Rod **CW.123.500**

WABCO : 911 145 737 2

Crankshaft **CW.208.601**

Bushing **CW.193.708**

Crankshaft Nut **MC202061FX**

M20x1.5 Right Hand Thread

VOLVO : 1698672

Bushing **CW.109.727**

52x48x19

Repair Kit **CW.208.904**

Gasket Kit **CW.208.913**

VOLVO : 85103938
WABCO : 412 352 004 2

Rear Cover **CW.153.721**

CW.244.000

 VOLVO
 20770303
 85000648

 WABCO
 912 512 006 0

VEHICLE APPLICATION
 B12B

Cylinder Bore	Ø85.00	Number of Cylinders	2	Water or Air Cooled	Water	Unloader Port Size	M16x1,5
Stroke	56 mm	Air Inlet Port Size	Ø35	Through Drive	Gear	Water Inlet Port Size	M16x1,5
Swept Volume	636 cm ³	Air Delivery Port Size	M26x1,5	With ESS System	Yes	Water Delivery Port Size	M16x1,5

Complete Cylinderhead

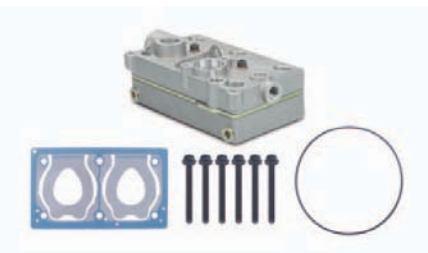
CW.244.100

 VOLVO : 20775236
 WABCO : 412 704 934 2

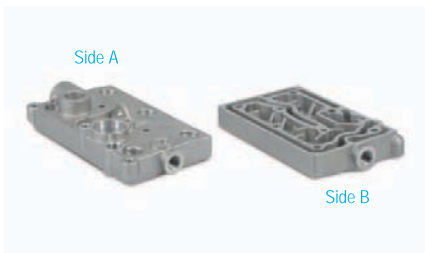
Cylinder Up head

CW.190.1020

Cooling Plate

CW.190.238



Cylinder Bottom Head

CW.190.1040

Repair Kit

CW.244.901

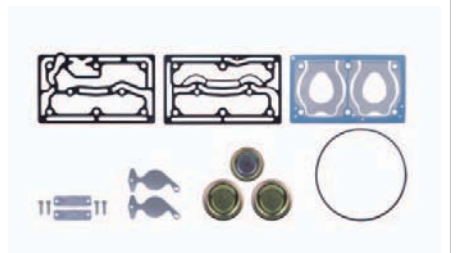
Repair Kit

CW.244.903





Piston & Ring

85.00 mm CW.109.350

85.25 mm CW.109.960

85.50 mm CW.109.970



VOLVO : 1698686
WABCO : 911 501 624 2 / 911 501 625 2

Piston

85.00 mm CW.109.351

85.25 mm CW.109.961

85.50 mm CW.109.971



Ring

85.00 mm CW.109.352

2.00+2.00+4.00

85.25 mm CW.109.962

85.50 mm CW.109.972



VOLVO : 3094621
WABCO : 911 501 920 2

Crankcase

CW.244.400



Connecting Rod

CW.109.500



WABCO : 911 145 737 2

Crankshaft

CW.244.601



Bushing

CW.109.727

52x48x19



Crankshaft Nut

MC202061FX

M20x1.5 Right Hand Thread



VOLVO : 1698672

Rear Cover

CW.193.619



WABCO : 912 000 340 4

Repair Kit

CW.244.912



VOLVO : 21322318 / 21477052
WABCO : 912 512 927 2 / 412 704 938 2

Repair Kit

CW.244.913



WABCO : 912 512 928 2

Sump Cover

CW.123.751



VOLVO : 3094835
WABCO : 895 073 589 4

CW.280.000

 VOLVO
 21225199
 85003351

 WABCO
 412 704 019 0

VEHICLE APPLICATION

 B9R
 B9L
 B9S
 B9TL

Cylinder Bore	Ø85.00	Number of Cylinders	2	Water or Air Cooled	Water	Unloader Port Size	M12x1,5
Stroke	56 mm	Air Inlet Port Size	Ø35	Through Drive	Gear	Water Inlet Port Size	M16x1,5
Swept Volume	636 cm ³	Air Delivery Port Size	M26x1,5	With ESS System	Yes	Water Delivery Port Size	M16x1,5

Complete Cylinderhead

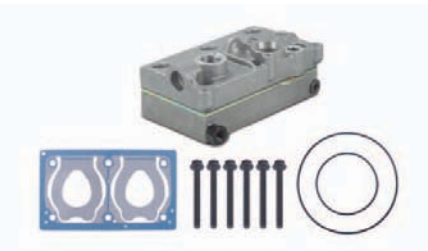
CW.280.100

 VOLVO : 21316442
 WABCO : 412 704 937 2

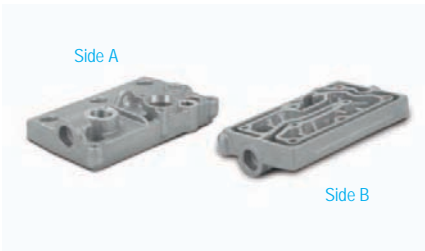
Cylinder Up head

CW.280.1020

Cooling Plate

CW.280.238

Cylinder Bottom Head

CW.280.1040

Repair Kit

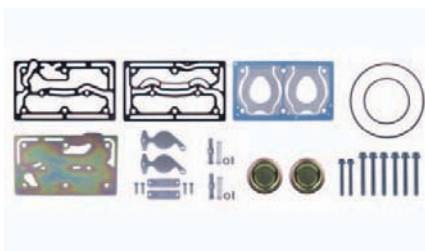
CW.280.901

Repair Kit

CW.280.903



Piston & Ring 85.00 mm CW.109.350

85.25 mm CW.109.960

85.50 mm CW.109.970



VOLVO : 1698686
WABCO : 911 501 624 2 / 911 501 625 2

Piston 85.00 mm CW.109.351

85.25 mm CW.109.961

85.50 mm CW.109.971



Ring 85.00 mm CW.109.352

2.00+2.00+4.00

85.25 mm CW.109.962

85.50 mm CW.109.972



VOLVO : 3094621
WABCO : 911 501 920 2

Crankcase CW.280.400



Connecting Rod CW.107.500



VOLVO : 1698678
WABCO : 911 505 732 2

Crankshaft CW.280.601



WABCO : 412 704 941 2

Bushing CW.142.434



WABCO : 411 522 340 4

Crankshaft Nut MC202061FX

M20x1.5 Right Hand Thread



VOLVO : 1698672

Rear Cover CW.142.720

Aluminum Bushing Cover



Repair Kit CW.280.904



Repair Kit CW.280.913



VOLVO : 21322318 / 21477052
WABCO : 912 512 927 2 / 412 704 938 2

Sump Cover CW.123.751



VOLVO : 3094835
WABCO : 895 073 589 4

CW.292.000

 VOLVO
 20824559

 WABCO
 912 512 007 0

VEHICLE APPLICATION

 B12B
 B12M

Cylinder Bore	Ø85.00	Number of Cylinders	2	Water or Air Cooled	Water	Unloader Port Size	M16x1,5
Stroke	56 mm	Air Inlet Port Size	Ø35	Through Drive	Gear	Water Inlet Port Size	M16x1,5
Swept Volume	636 cm ³	Air Delivery Port Size	M26x1,5	With ESS System	Yes	Water Delivery Port Size	M16x1,5

Complete Cylinderhead

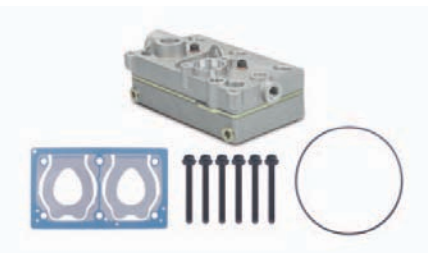
CW.244.100

 VOLVO : 20775236
 WABCO : 412 704 934 2

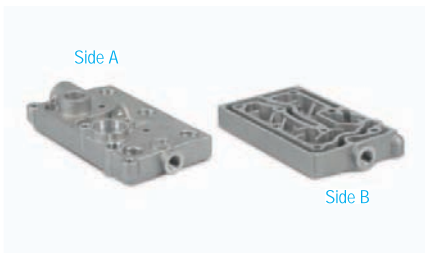
Cylinder Up head

CW.190.1020

Cooling Plate

CW.190.238

Cylinder Bottom Head

CW.190.1040

Repair Kit

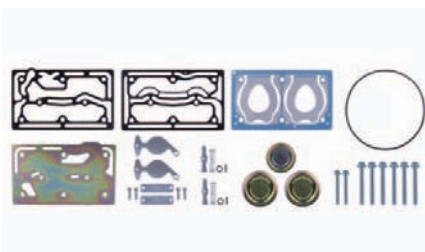
CW.244.901

Repair Kit

CW.244.903

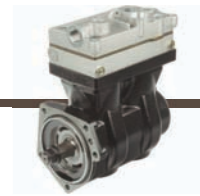
Piston & Ring 85.00 mm CW.109.350

85.25 mm CW.109.960

85.50 mm CW.109.970



VOLVO : 1698686
WABCO : 911 501 624 2 / 911 501 625 2

Piston 85.00 mm CW.109.351

85.25 mm CW.109.961

85.50 mm CW.109.971



Ring 85.00 mm CW.109.352

2.00+2.00+4.00

85.25 mm CW.109.962

85.50 mm CW.109.972



VOLVO : 3094621
WABCO : 911 501 920 2

Crankcase **CW.292.400**



Connecting Rod **CW.109.500**



WABCO : 911 145 737 2

Crankshaft **CW.244.601**



Bushing **CW.109.727**

52x48x19



Crankshaft Nut **MC202061FX**

M20x1.5 Right Hand Thread



VOLVO : 1698672

Rear Cover **CW.193.619**



WABCO : 912 000 340 4

Repair Kit **CW.244.912**



VOLVO : 21322318 / 21477052
WABCO : 912 512 927 2 / 412 704 938 2

Repair Kit **CW.244.913**



WABCO : 912 512 928 2

Sump Cover **CW.123.751**



VOLVO : 3094835
WABCO : 895 073 589 4